

See more
on the web



UNIRACK

USA / USB / USM / USP / USR

PATENTED MODULAR SHELVING

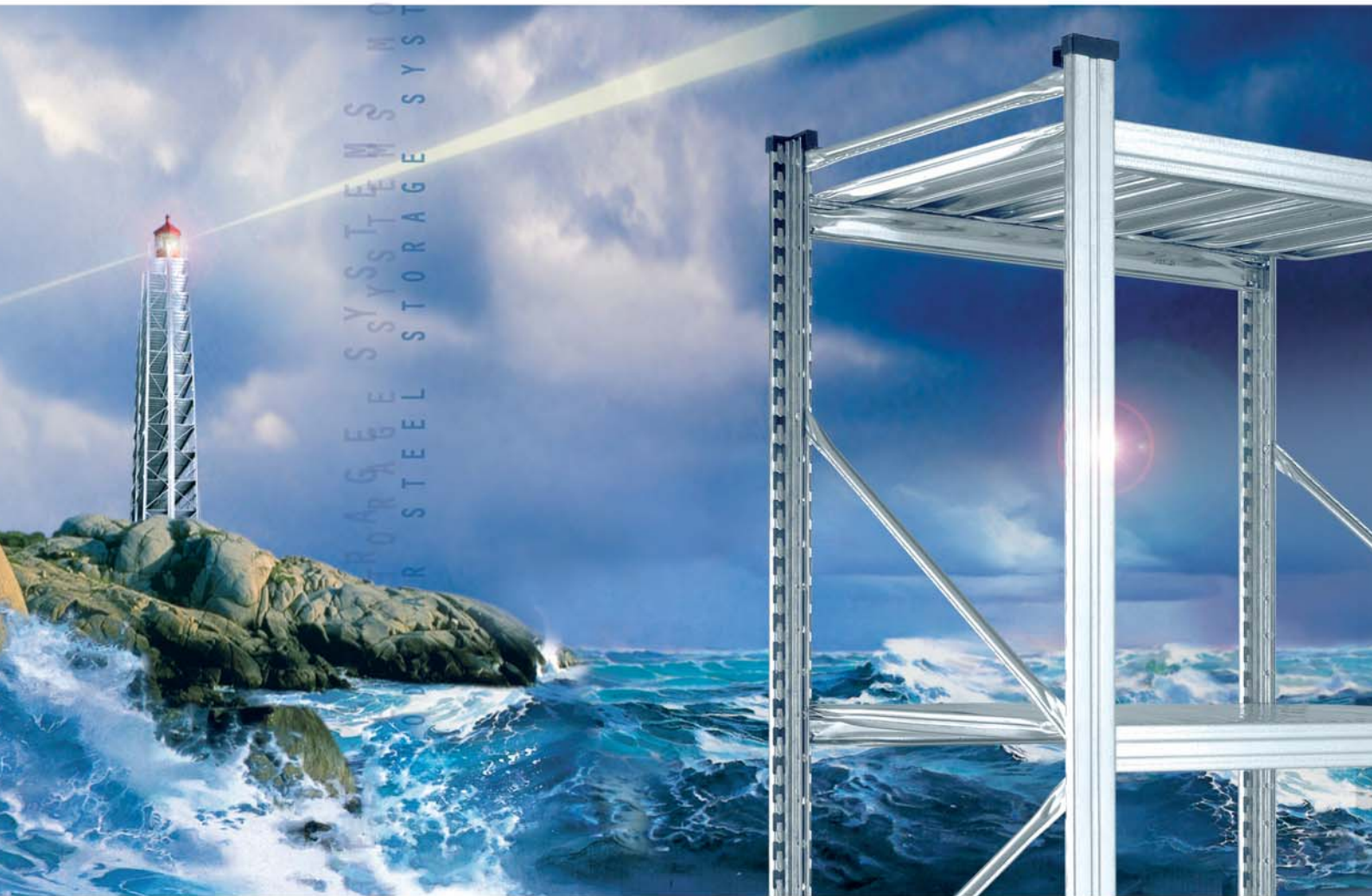

TEMPERATURE MODULAR



METALSISTEM[®]
STRUTTURE ED AUTOMAZIONE
MADE IN ITALY 

See more
on the web



THE GROUP



Founded in 1968, METALSISTEM commenced its activities specialising in the design and production of machinery for the cold profiling of metals.

The experience gathered, numerous highly innovative patents resulting from intense research and development and the considerable market success of the first range of cold form zinc coated profiles quickly channelled METALSISTEM into the production of the latter of its activities. Today the METALSISTEM Group is an articulated network of companies with its head office and main production facility in Rovereto, Italy.

The Group has consolidated its position as one of the major industries within the Material Handling Sector.

Through products and services aimed at providing complete assistance for all warehousing, product showcasing and sales outlet requirements, the companies of the METALSISTEM Group are able to offer their customers a wide range of products of the highest quality, highly competitively priced, with very rapid delivery times and a first class back up service, as well as tailor made solutions providing efficient and rational use of internal storage areas and material handling environments.

Lightness, strength and modular form, coupled with the ease of integrating and expanding already existing structures are but a few of the successful features of the METALSISTEM storage and shelving systems.

The success of the METALSISTEM Group is the result of a precise managerial choice based on research of new production technologies and continuous development and innovation of its product range.

A direction which has produced numerous international patents (testament to the uniqueness of the METALSISTEM product), continuing improvements in safety, quality and versatility. METALSISTEM's company strategy is to offer

products of the highest quality, very competitively priced, with rapid delivery times backed up by a first class service.

The numerous product lines are conceived and designed by METALSISTEM's internal Research and Development Centre, as are the profiling lines and equipment required for their manufacture.

The automated production facilities for the cold profiling of metals have enabled METALSISTEM to achieve one of the highest levels of productivity in the world, today.

Rigorous laboratory tests are conducted on the raw material entering production, and on the final product, thus ensuring the continuing evolution of efficiency and quality standards.

All products have elevated structural characteristics and ensure high quality standards recognised by the most important European certification bodies, such as Germany's TÜV Product Service GmbH, Austria's Ö-NORM, Rome's I.S.P.E.S.L, UNICMI - ACAI/CISI (Associazione Costruttori Acciaio Italiani - Sezione Costruttori Italiani di Scaffalatura Industriale), the latter of which METALSISTEM has membership, and others.

The company's ISO 9001 quality assurance system as well as its environmental management system ISO14001 and the health and safety BS OHSAS 18001, are certified by RINA.

With an annual turnover of exceeding 260 Million Euro, the METALSISTEM Group premises occupy a total area of 230.000 m², 125.000 of which are dedicated to production.

The METALSISTEM Group affiliated companies and distributors provide a world wide commercial network, able to satisfy the most demanding needs.

We value greatly the high level of trust that is placed in us by our customers and feel that it is proof of the quality and reliability of our products.



STANDARD SPECIFICATIONS CALCULATION AND SAFETY STANDARDS

The correct use of a product, distinguishes both the Customer and the Manufacturer. METALSISTEM recommends that Customers make use of their product in strict conformity with the design characteristics given and standards of best practice. The design and assembly of the racking systems must be carried out by qualified personnel.

METALSISTEM declines all responsibility for improper or non authorized use of the racking and its accessories.

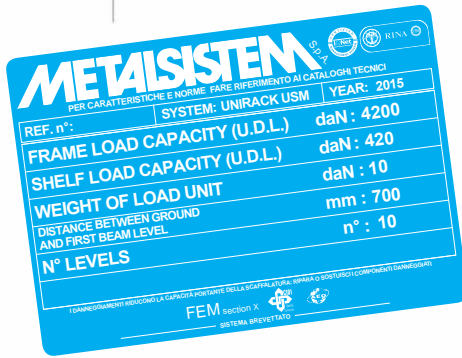

a. Floor slab loading

Loading capability should be checked before installation.

b. Site installation

It is of utmost importance that installations are assembled by skilled labour only. Frames should be built in strict accordance with the assembly diagram shown in this brochure. Particular attention should be paid to a proper assembly and location of security pins.

c. Rack alignment

Once the shelving is assembled, it is necessary to align it vertically and horizontally.

The perpendicular deviation should not exceed 1/200 of the height (with a maximum of 20 mm) and correspondingly the horizontal deviation 1/300 of the bay length. See fig. 1.

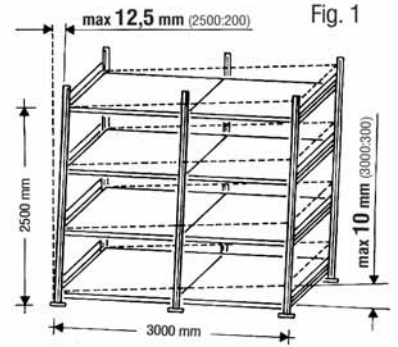

d. Load bearing capacity plate

Load capacity plates should be fixed in a prominent position and show the product series, the year of construction, the maximum load per frame, per shelf and per sq.mt. (in the case of platforms and/or two-tier structures), as well as the weight of the load units, the distance from the ground to the first load level and the total number of load levels.

e. Rack safety standard

In the case of hand loaded static shelving, if the height of the frame is over 3 metres or exceeds over 5 times its depth, the frames must be securely bolted to the floor slab using the metal base plates art. SLACC001.95 and fitted with wall ties or overhead ties (see fig. 2). It is not allowed to use single sided shelving that exceeds over 8 times its depth, unless the frames are connected through walkways or fitted with wall ties.

The use of cross bracings (vertical and horizontal cross bracing) is necessary in the case of rack runs with frame heights over 3 metres, with less than 4 bays or with distances of more than 700 mm in height between the load levels.

In such cases it is necessary to provide vertical and horizontal cross bracing in intervals of at least one bay each 8 bays in a row.

The frames must be securely bolted to the floor slab using the metal base plates art. SLACC001.95.

As an alternative solution to the use of cross bracings, customers may fit the shelving with wall ties or similar. This is valid only in case that the wall or the structure is adequate for that scope and provide an equal or better grade of constraint compared to cross bracing.

Within seismic regions, it is not allowed at all to use any type of wall ties or similar. In such cases we recommend the use of our heavy duty cross bracing system, following the indications of METALSISTEM Informa n° 688. For a correct calculation and layout please refer to METALSISTEM's Technical Department.



DIAGRAM FOR ASSEMBLING UNIRACK FRAME BRACING USA - USB - USM - USP - USR

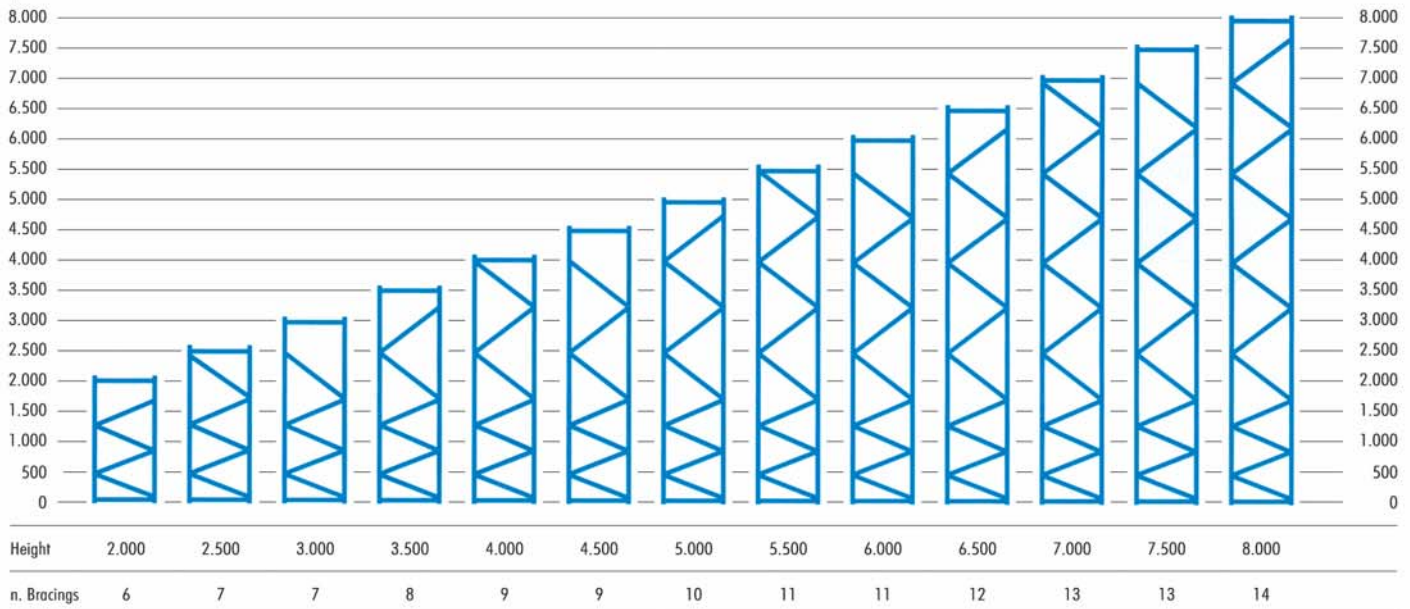

f. Installation design

Unirack structures are to be used as hand loaded shelving only and not as pallet racking, with forklifts, or with wheeled equipment on two-tier structures.

METALSISTEM declines all responsibility for improper or non authorized use of the shelving and its accessories.

g. Two tier structures/platforms

Two tier structures with suspended walkways or platforms with continuous floor/decking are to be designed exclusively with USM-USR series or with the reinforced USM-R/USR-R series and must comply with all safety recommendations. The correct use of all safety components mentioned in this brochure is mandatory. Staircases built with modular Unirack components and integrated into shelving structures must be adequately reinforced and built with reinforced USR-uprights (article code n° USR0--/R.95). The frame bracing pattern of staircase frames may be interrupted at walkway level only (at a height of approx. 2.400 mm from ground), adding a horizontal frame spacer bar below and on top of the interruption. The uprights of staircase frames are to be bolted to the floor slab using two dowels M8x50 (article code n° 00040.20).

The maximum load bearing capacity of walkways/decking within two-tier structures and platforms is 300 daN/m² and the maximum width of walkways is 1200 mm. The max. shelf bay length is 1500 mm.

Two-tier-structures and platforms have to be equipped with appropriate vertical and horizontal cross bracing.

The frames must be fitted with overhead ties.

For installations designed with seismic criteria, it is mandatory to use a shelf combination S3/H25-B at walkway level and to add a horizontal frame spacer bar into the frames.

h. Reference standards

The structural calculation reference standards are:

- UNI EN 15512:2009; UNI EN 15620:2009; UNI EN 1993-1-3:2007 Eurocode 3.

Materials reference standards are:

- UNI EN 10346:2009; UNI EN 10149-1:1997; UNI EN 10149-2:1997; UNI EN 10204:2005.

Other reference standards:

- UNI EN 15635:2009; ACAI-CISI – Testo Unico - dated 11.05.2004 and 26.02.2004.

i. Calculation

Finite elements standard calculation are made with the aid of the ANSYS program. Guide lines followed as basis for the calculation are those of the Italian "CISI" association (CISI = Association of Italian Manufacturers of Steel Shelving).

j. Frame load capacity

The frame load bearing capacities stated in this brochure are calculated in compliance with the following criteria: the first shelf level must be fitted at no more than 700 mm from the ground and the following levels at intervals not exceeding 500 mm, with a minimum of 4 interconnecting bays. Frames are to be bolted to the floor slab. The standard design and calculation referring to the Unirack series is valid for hand loaded shelving only, without any seismic criteria. In case of Unirack installations designed for Miniload applications or Unirack installations designed for seismic areas, please refer to METALSISTEM's Technical Department.

k. Shelf load bearing capacity

Data for shelf load bearing capacities shown in the brochure are to be understood as referring to uniformly distributed loadings with a deflection equal to 1/200 of the shelf length. The beam locking pins must always be fitted.

l. Custom- built applications

The METALSISTEM Technical Department is at its customers' disposal for any specific calculation or custom-built application.



METALSISTEM reserves the right to apply technical changes to the product. Data, characteristics and dimensions given in this document are merely indicative.

DIMENSIONS FOR THE DESIGN OF USA-USB-USM-USR SERIES

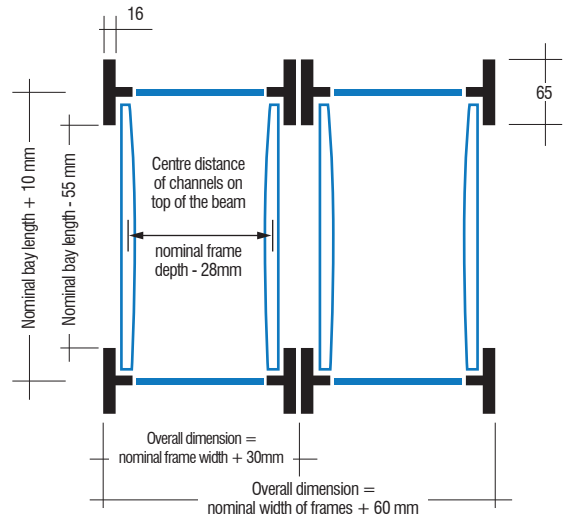

IMPORTANT: ensure the two uprights of the frame to be perfectly parallel, before tightening the bolts.

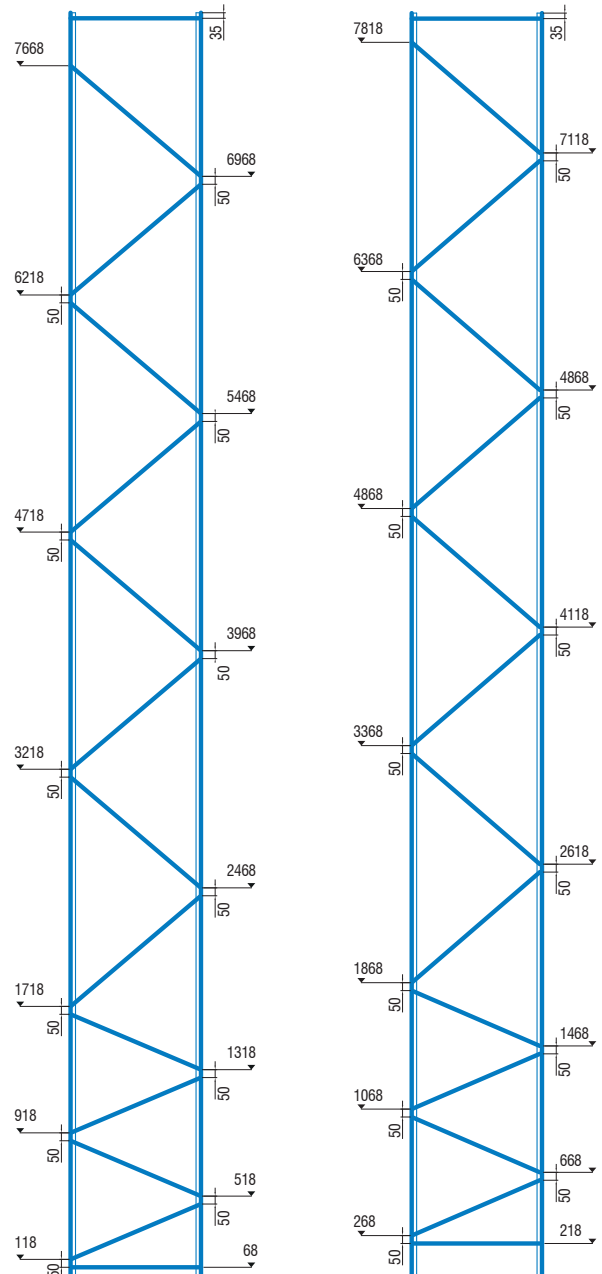

Article: SLACC001.95
metal base plate

Article: 67006.95
heavy duty base plate



THE COMPANY TODAY

METALSISTEM products are now in use in many installations throughout the world, and after more than 45 years production, we value greatly the high level of trust that is placed in us by our customers and feel that it is proof of the quality of our products.

Our customers are able to alter and extend their existing installations with the same components and the greatest of ease.

Product development, production and turnover is steadily increasing.

Delivery and installation of even major projects can be achieved very quickly. This is possible due to the high rate of production coupled with an extensive network of distributors world-wide, extreme ease of assembly and a very rapid installation time.

The practical structural testings are verified by rigorous commissions in the field of quality and safety certification.





THE PRODUCT

The Unirack USA-USB-USM-USR-USP structures have been designed and implemented to meet the needs of light to medium duty storage: they are also highly suited to the construction of single, two and even three tier structures up to a height of 8 metres with frame loadings up to 4800 daN (in USR version).

The design of the various components is the result of rigorous technical testing and the highly specialised knowledge developed over years of experience in the field of metal processing.

This experience has enabled METALSISTEM to offer innovative products of the highest quality, highly competitively priced, and to produce a highly technical solution to the most important shelving problems, such as rapid assembly, stability, low cost and high load bearing capacity.

The special design allows for high load bearing capacities from light gauge materials.

The use of high quality zinc coated steel ensures a high level of durability. The versatility of the system allows the easy use of dividers and modular containers for storage and separation of small loose parts.

The structural components of the Unirack systems are made from high tensile steel, certified according to EN 10204 3.1.

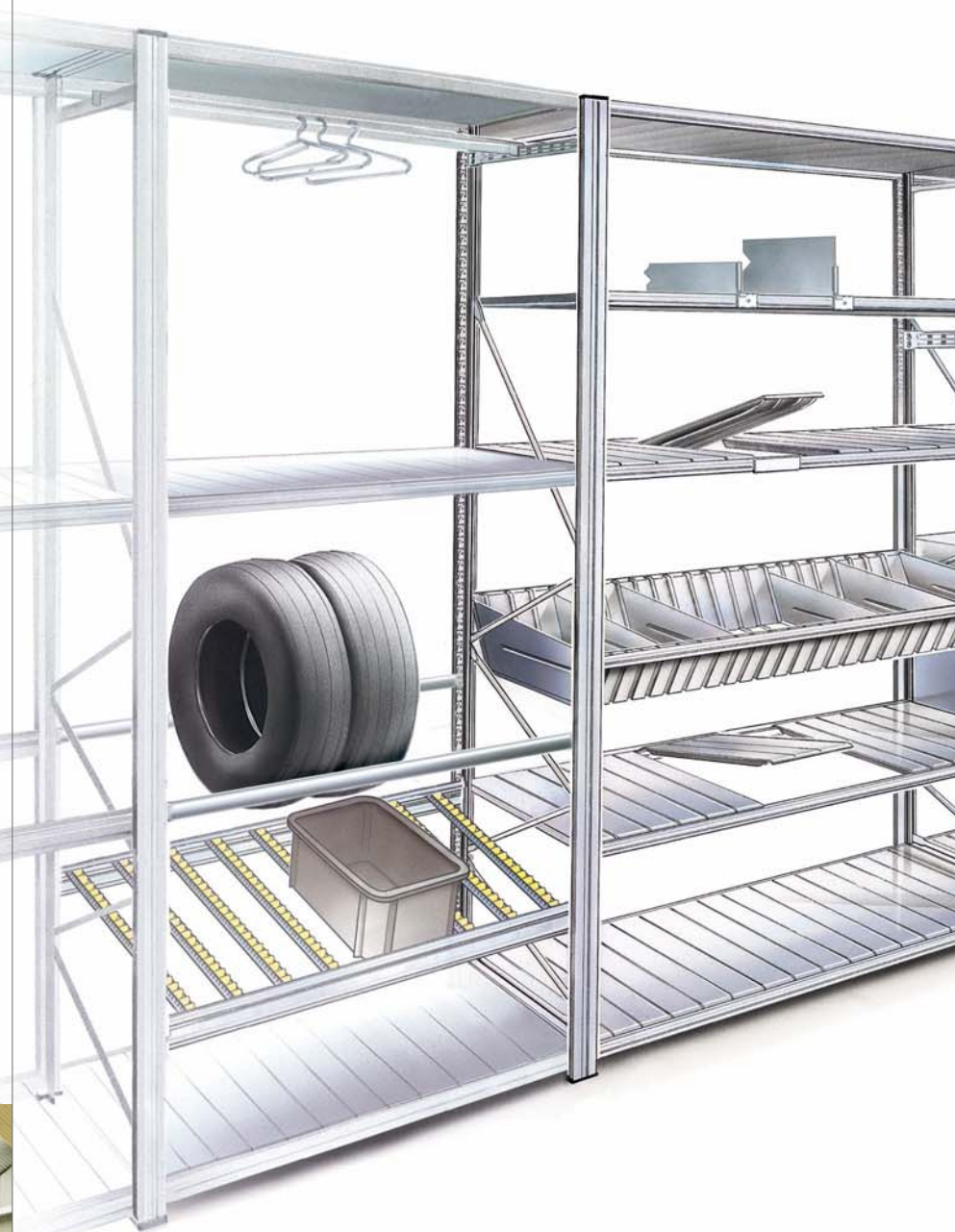

See more on the web



See more on the web

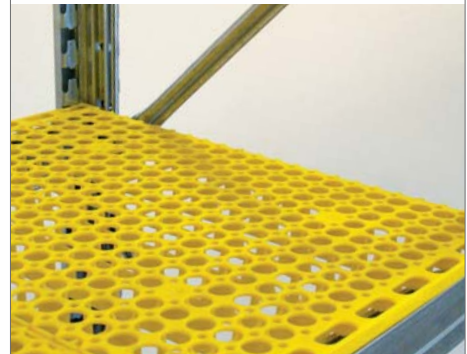
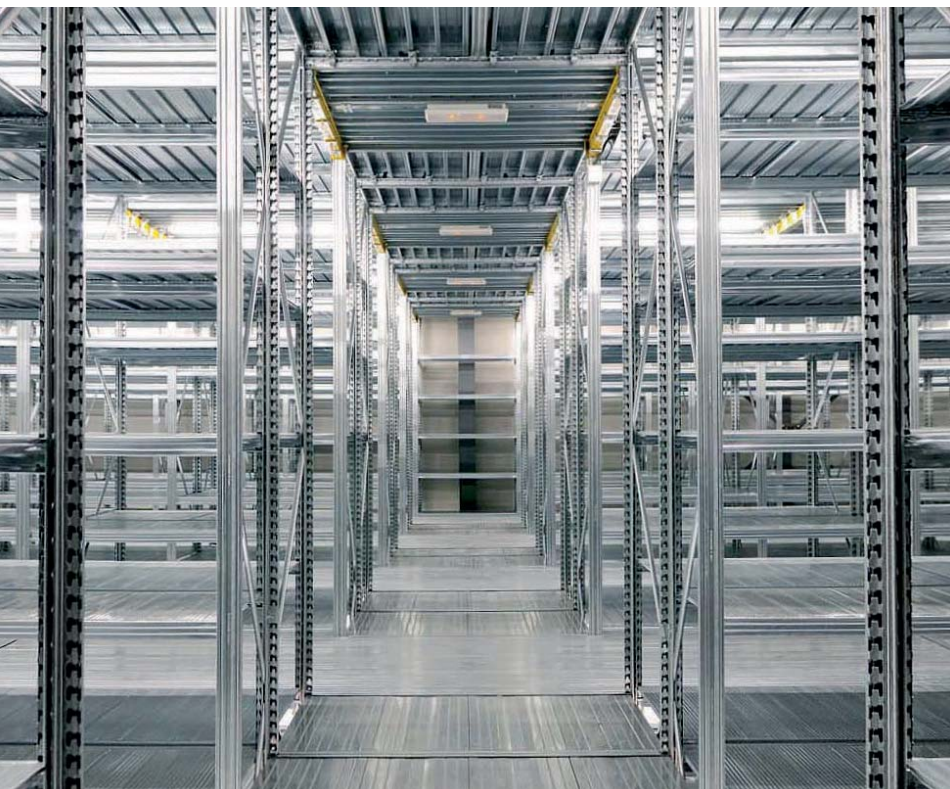

The safety and the quality of the product have always been a primary aim of METALSISTEM and are recognised by TÜV Rheinland PRODUCT SAFETY GmbH, one of the most rigorous E.C. commissions in the field of quality and safety certification.

Thanks to its attractive high-tech design Unirack shelving is trendy and pleasing to the eye. It can provide unique solutions for shopfitting and applications in domestic environments.



ASSEMBLY INSTRUCTIONS

Uprights and Frames

The USA-USB-USM-USR frame components are interchangeable. Beams are located on the inside of the uprights (Ref. 1, 2). The USP series (Ref. 1b) is used to locate H30 solid shelves into the vertical slots in the upright. Using steel of varying gauge, the three frame types have different load capacities:

- Series USP : 2300 daN
- Series USA : 2600 daN
- Series USB : 3000 daN
- Series USM : 4200 daN
- Series USR : 4800 daN

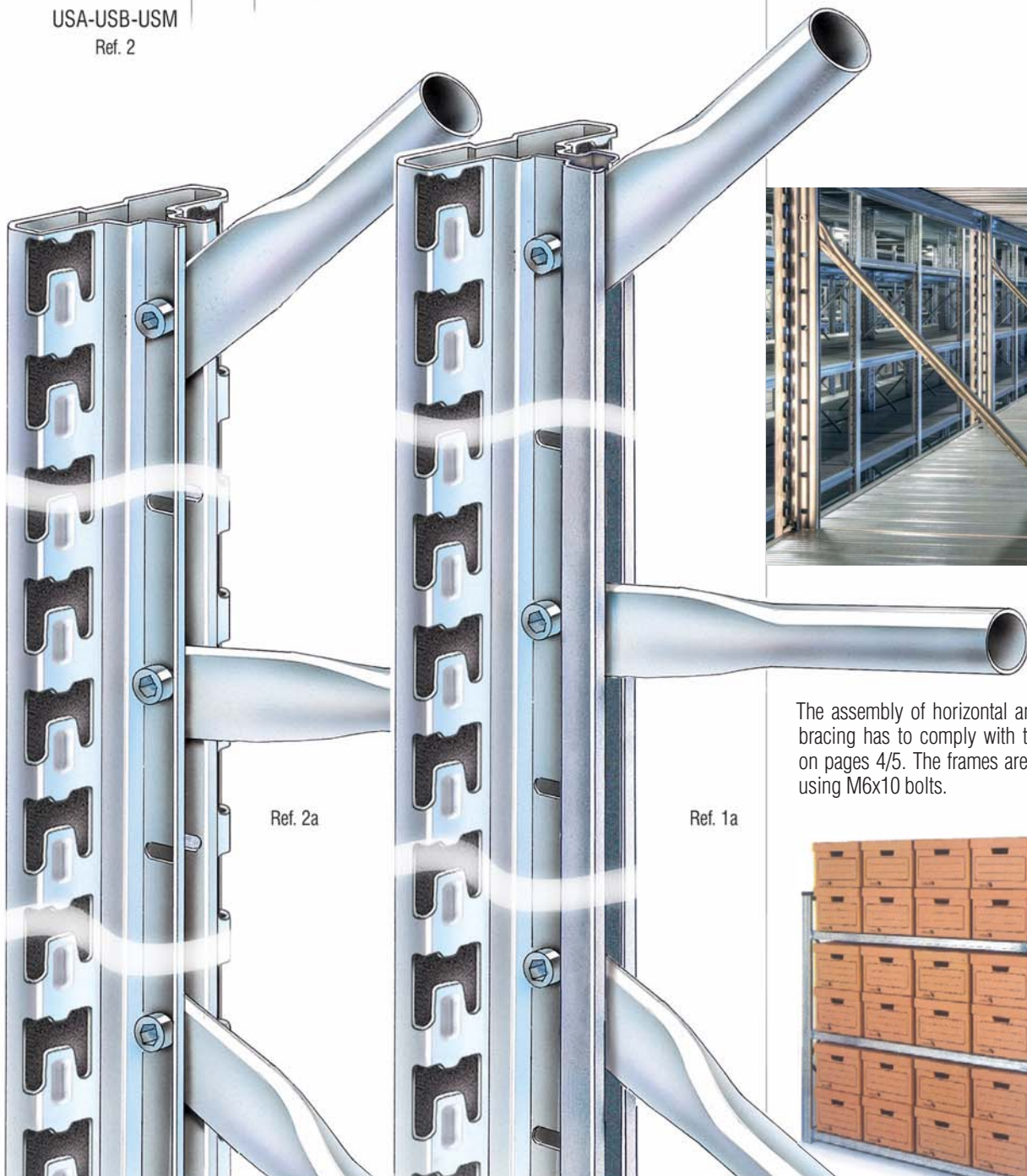

The assembly of horizontal and diagonal bracing has to comply with the diagram on pages 4/5. The frames are assembled using M6x10 bolts.



Base Plates

Plastic base plates are fitted by pressing them onto the uprights. They are recommended only for the USA and USP series. In any case, the safety standards as per point e) on page 4 must be adhered to. Plastic bases can also be used as top caps to finish off the uprights.

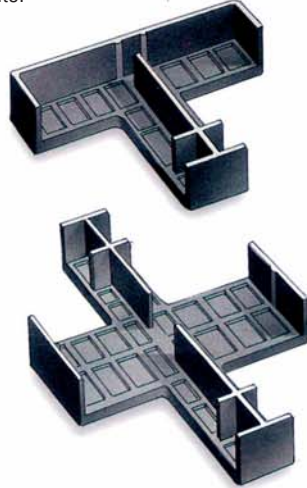

Ref. 4

Metal base plates can be fitted in two different positions:

- a) turned inwards, flush with the front face of the upright,
- b) turned outwards, both can be bolted to the floor slab.

The metal base plates are fastened to the uprights by means of M6x10 bolts. (Ref. 4)

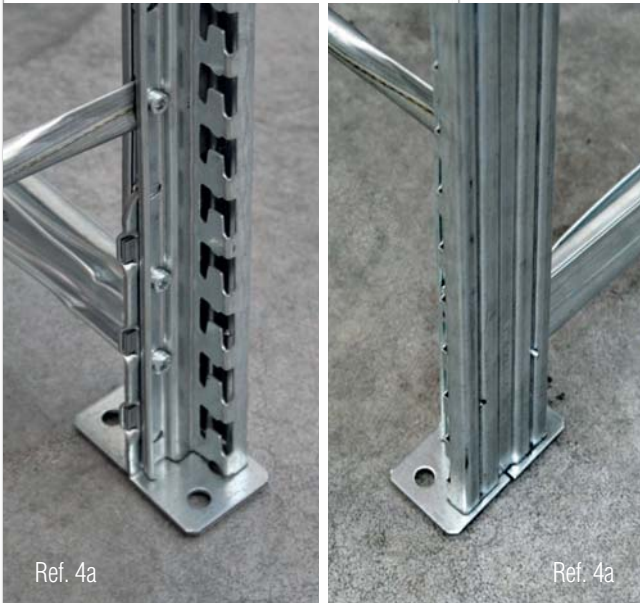
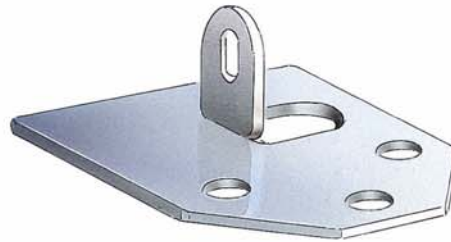

Heavy duty base plates are used for installations designed with seismic criteria or for special applications. They are fastened to the upright by 2 screws and bolted to the floor slab using 2 dowels M8x50.

When using heavy duty metal base plates, the first shelf level is set at a height of 226 mm from ground. (Ref. 4a)



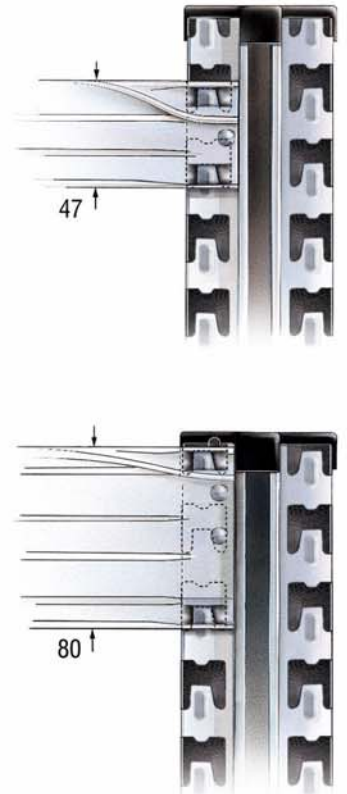
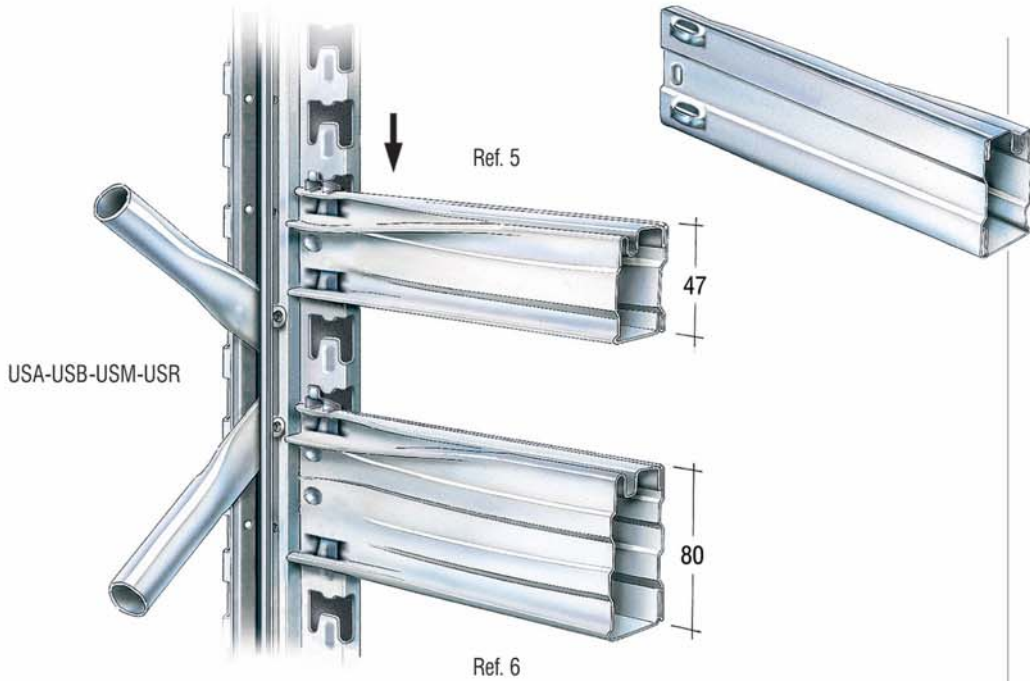

Beams

Take the frames, assembled with bracing and base plates: keep them as perpendicular as possible and fit the beam by tapping it down onto the tongues, close to the upright, with a plastic-faced hammer to avoid damage to the beam (Ref. 5).

The beams are compatible on the four frame types USA-USB-USM-USR except the USP series which can be fitted with the solid shelves H30 only.

Each type of beam H47/80, the tubular beams and the "T-Section" support bars, once assembled, must be secured with the respective locking pin (see page 21).

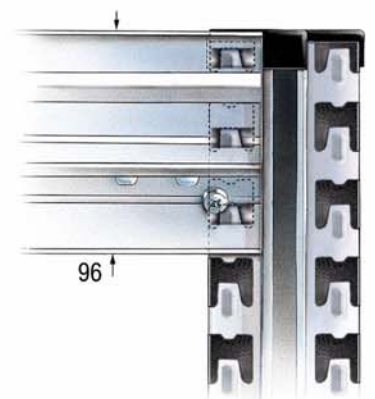
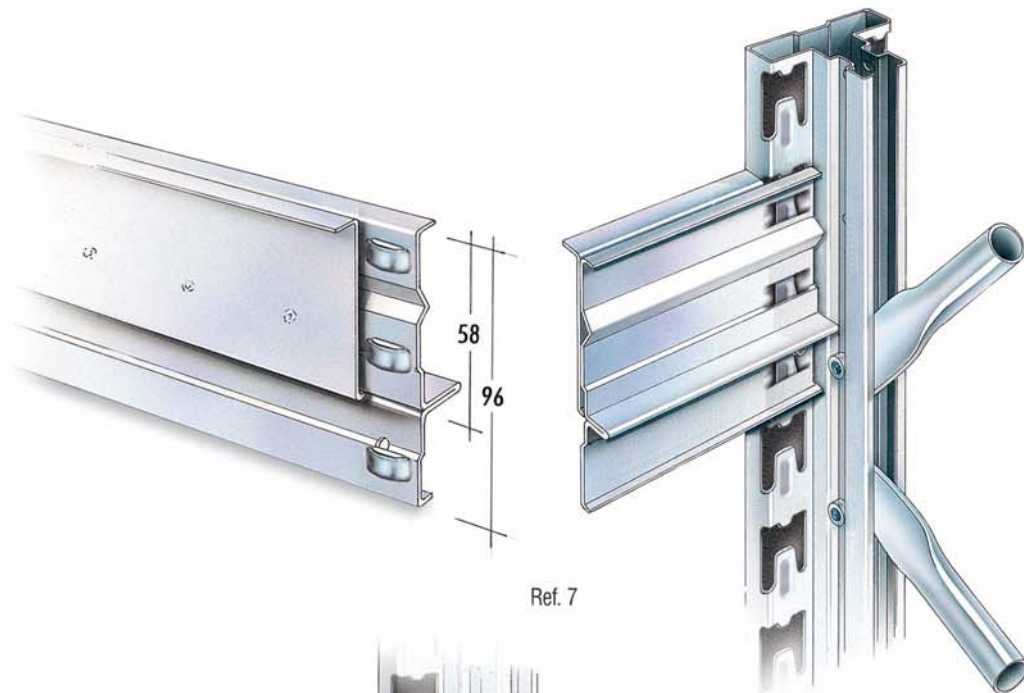

Shelves H12 and H25

Shelves of profile 12 mm, 450-600-900 mm wide, are produced in depths varying from 320 to 700 mm (Ref. 11).
Shelves of profile 25 mm and 300-200-150 mm wide are supplied in depths varying from 400 to 800 mm (Ref. 13).

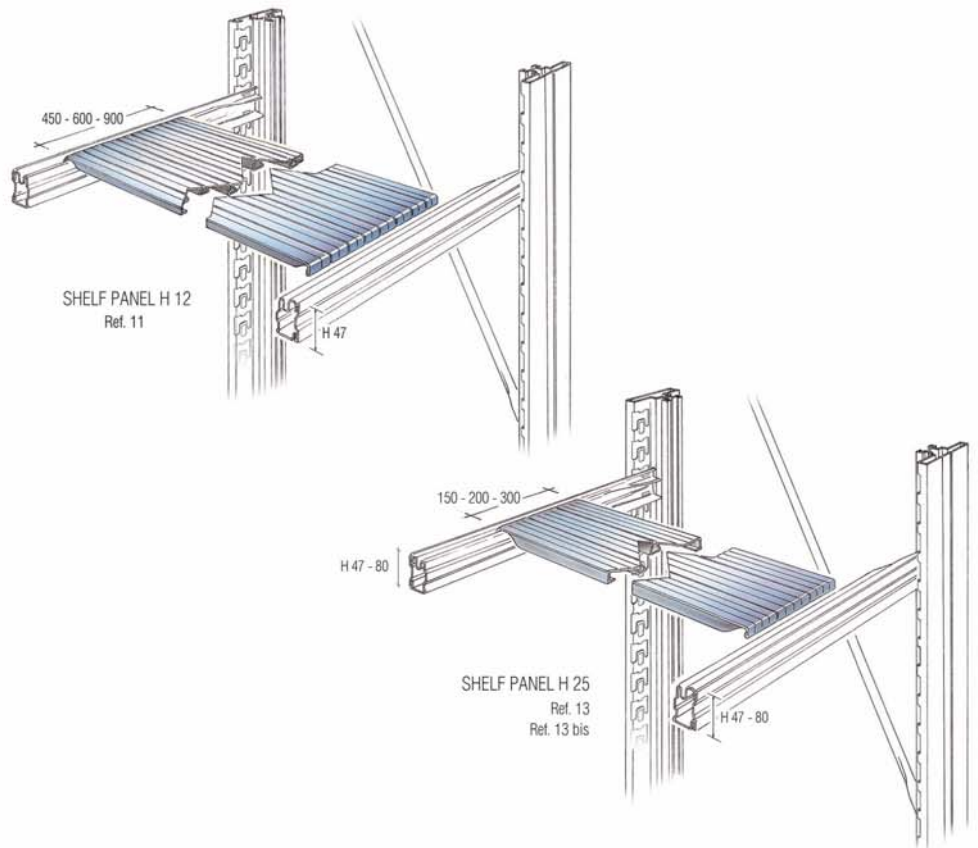
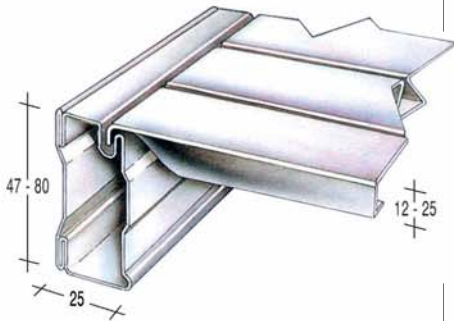

Perforated Plastic Shelf Panels

The standard range of perforated plastic shelf panels in 150-200-300 mm width is made from high quality polypropylene according to the RoHS directive, suitable for use within the food sector and RoHS compliant. The shelf panels are perforated at >50% of their surface. Available in six different colours: white, yellow, light blue, blue, dark green and black, for frame depths 320-400-500-600 mm.

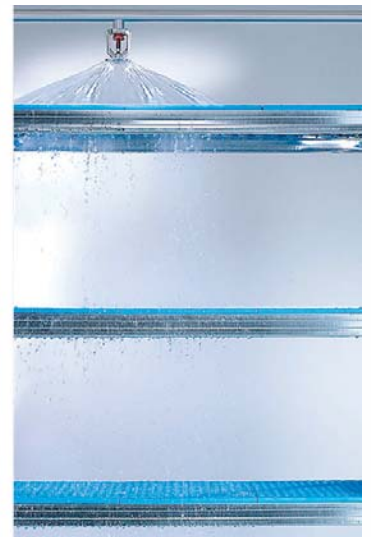
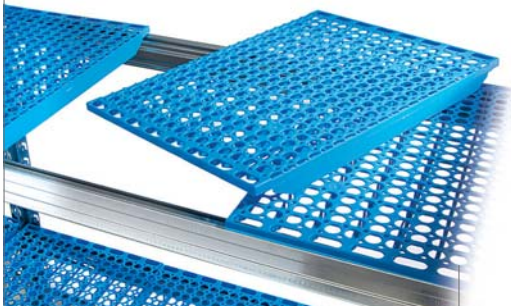

Specific FROST shelf panels in light green colour are also available for use within cooling rooms.
For correct ordering and load bearing capacities, please refer to page 48/49 of this brochure.

Perforated Steel Shelf Panels

Perforated steel shelves of profile 25 mm in 300 mm width, perforated at 50%. For installations equipped with sprinkler systems. Hole diameter 6.5 mm.
For correct ordering and load bearing capacities, please refer to page 46 of this brochure.

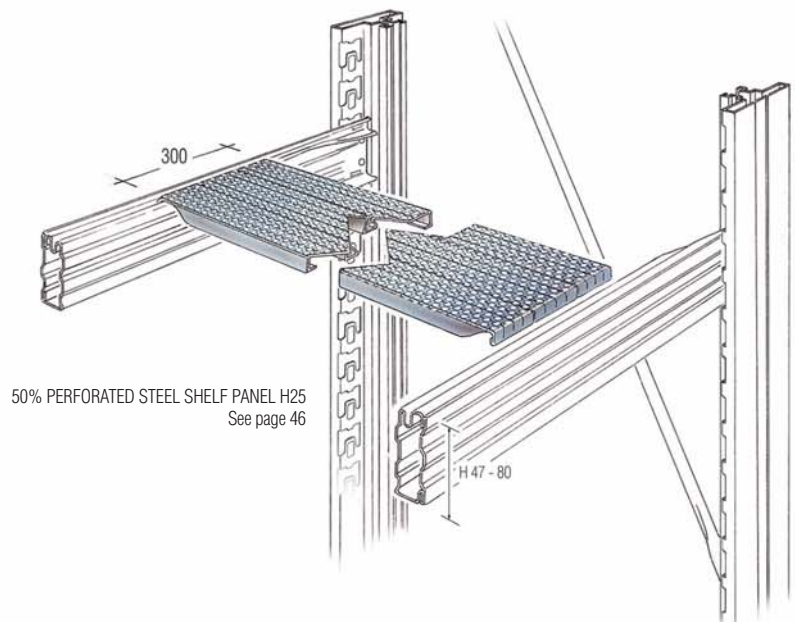



Corner Solutions

Corner solutions allow for the best possible use of available storage space, especially within small and awkward rooms. By means of 4 dedicated brackets, both left and right sided corners can be created without the need of inserting additional frames which would hinder full access to the shelving levels. "T"-shaped peninsular configurations may also be created by coupling left and right sided beam connection brackets. With appropriate consideration, this application may also be used to close off end corridors of 2-tier-installations (Ref. 67).

Applications are limitless!

For a correct layout, load bearing capacities and technical specifications referring to corner solutions, please refer to page 50 of this brochure.

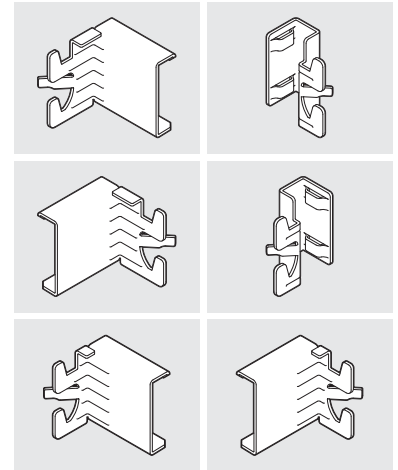

Solid Shelves

The solid shelves H30 mm are located on four shelf clips as shown below. Shelf levels are adjustable in 50 mm increments.

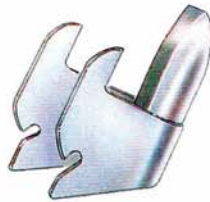
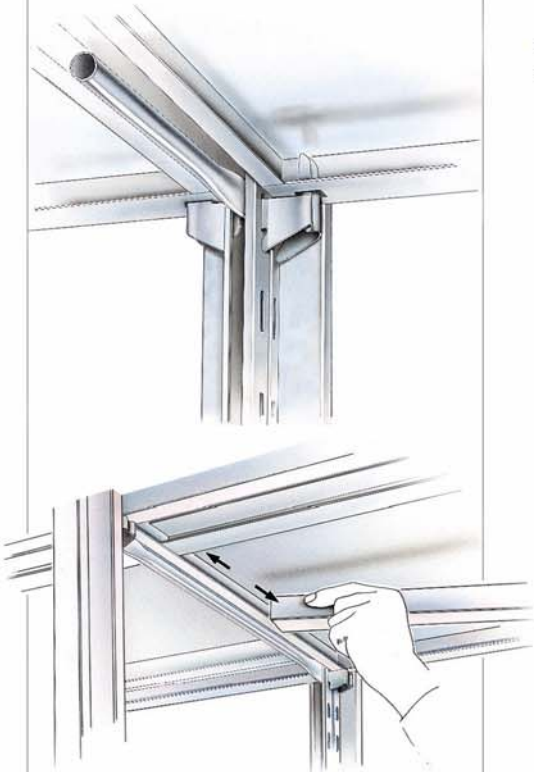

DIMENSIONS FOR THE DESIGN OF USP SERIES

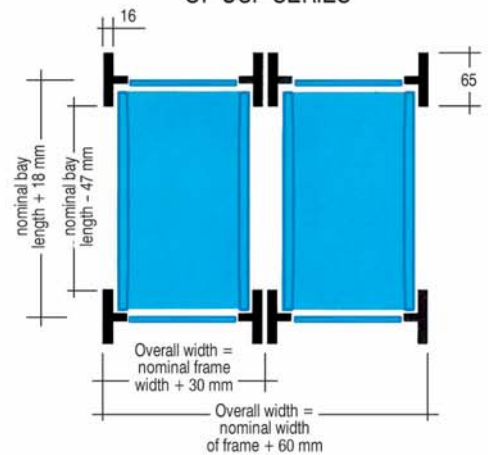

Solid shelves H30 mm are used with up-rights of the USP series only. It is possible to add two reinforcement profiles to increase the load capacity of the shelf (Ref. 14). These profiles must be pressed against the two folds of the shelf.

Chipboard Shelves

Chipboard shelves of thickness 12 or 18 mm can be fitted using the clips shown at right (Ref. 15).

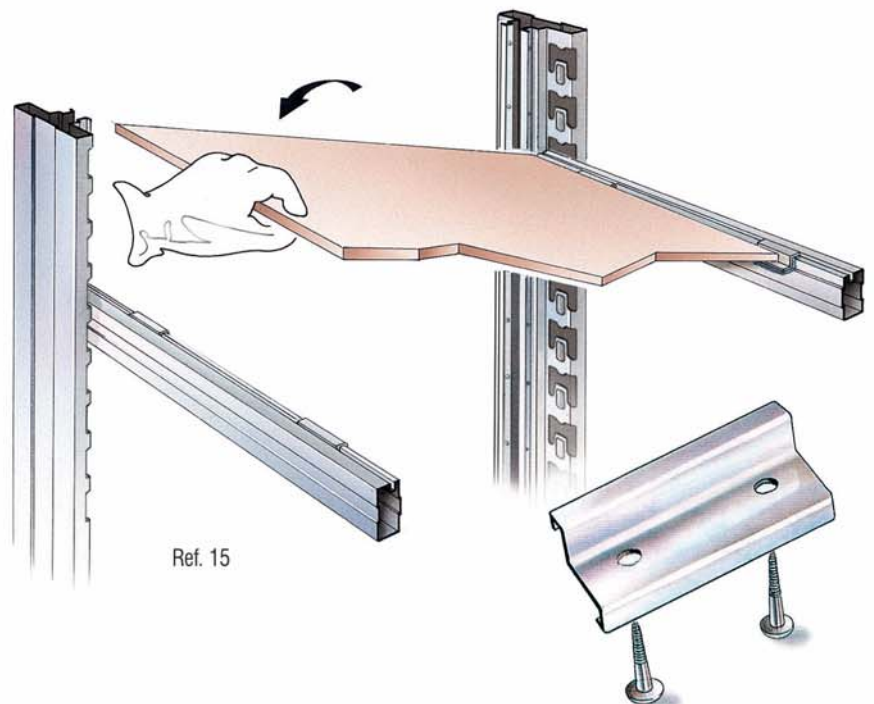
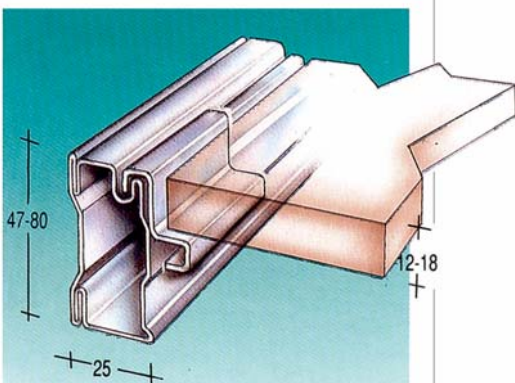

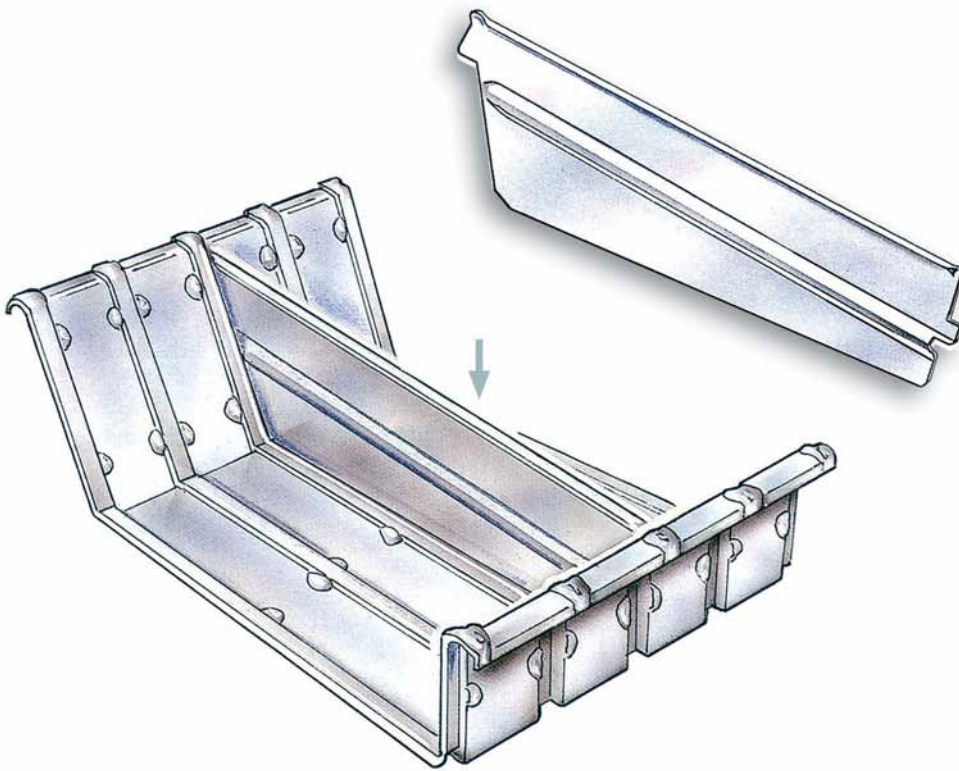

Ref. 16

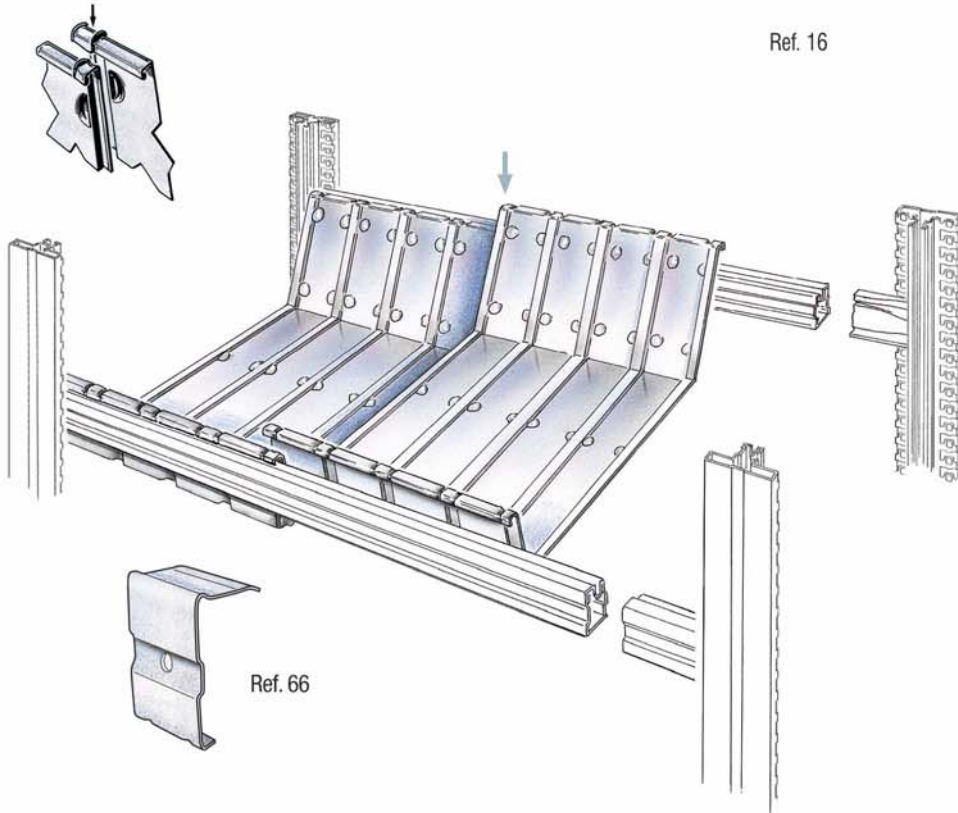

Ref. 66

Modular Containers

Insert the container from left to right, and join them together by overlapping the beginning of the following container onto the end of the preceding one, pressing them into the recess of the beams H47/H80. To assemble the containers correctly, the rear beam should be fitted two pitches higher than the front one (Ref. 16).



Ref. 66



Ref. 66

Fastening Clip for Modular Containers

This clip prevents the modular containers from being accidentally unseated from their position (Ref. 66).

Skip the first container to the left of the bay and fix each of the following modular containers using a pair of clips positioned on the second rib at the front and at the back of the container.

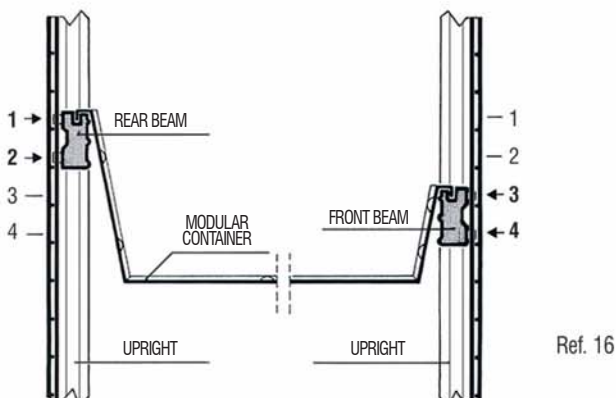

Ref. 16

Fit the dividers into the special slotted seats, pushing down to locate (Ref. 16). Modular containers and dividers are supplied to a maximum depth of 800 mm.

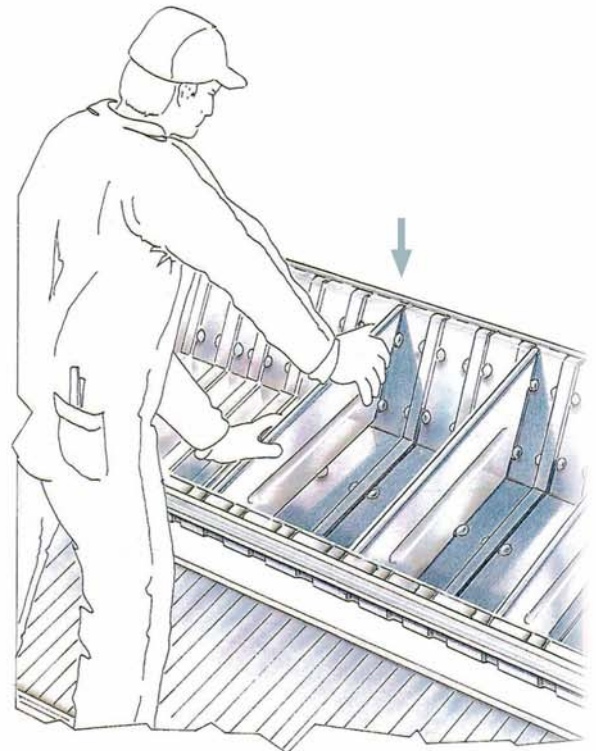

The capacity of the containers can be increased by fitting bin front and rear panels 200 or 300 mm high. See page 52 (art. n° 64016.95 - 64040.95).

Ref. 16

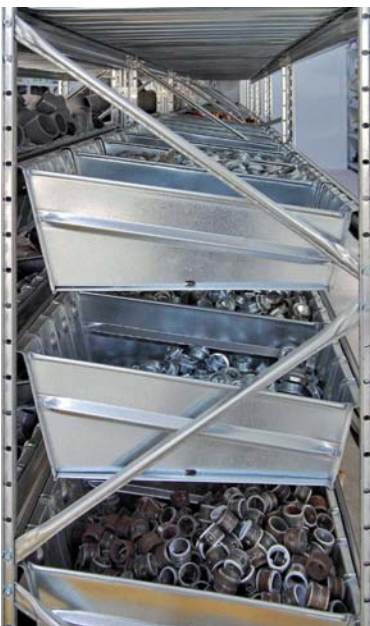

DIVIDERS

A large range of dividers is available.

Vertical Sliding Dividers

These have been designed to separate boxed items (Ref. 17).

The concept of these dividers is based on the following components: a pair of clips (left and right) available for H47 beams, and vertical dividers, available for all frame depths and in two different heights (H100mm / H200mm), as well as in the trapezoidal version (H200/100 mm).

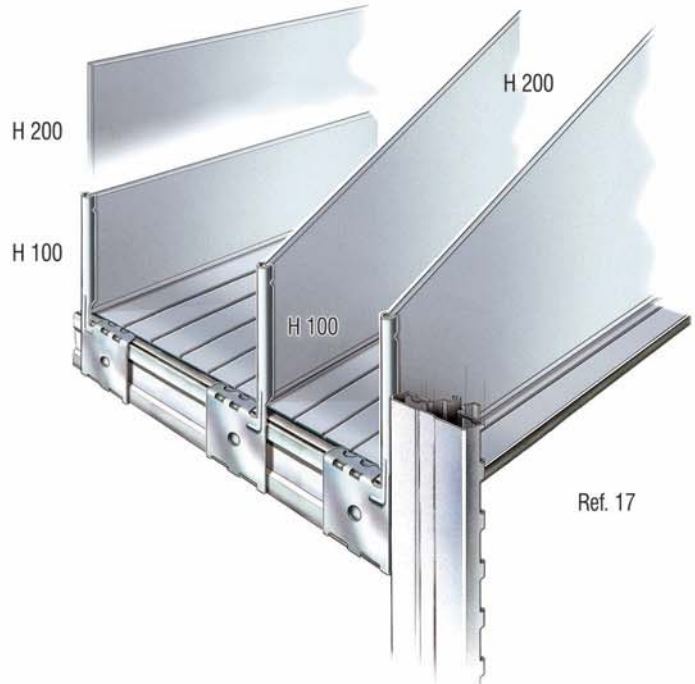

Shelf Trays

These comprise of a bin front and rear panel 100 mm high placed on a normal shelf with adjustable dividers from 320 to 800 mm in depth (Ref. 20). Bin front panels 100 mm high and rear panels 200 mm high are fitted with trapezoidal dividers (Ref. 21/22).

Modular Drawers

The modular drawers are fully integrated with the Unirack series and are located directly on the frames.

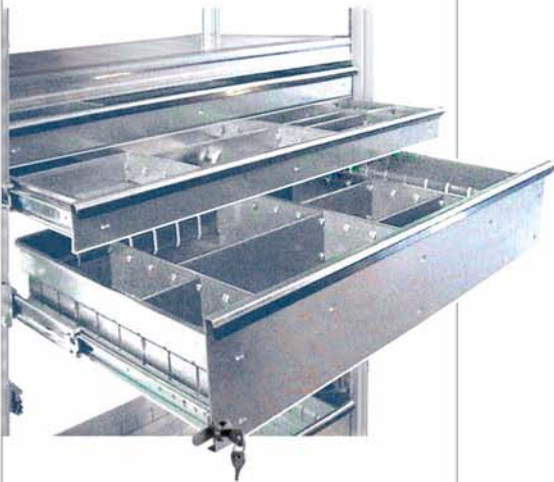

The drawers provide a cost effective solution for the storage of small items and may be fitted with a key lock.

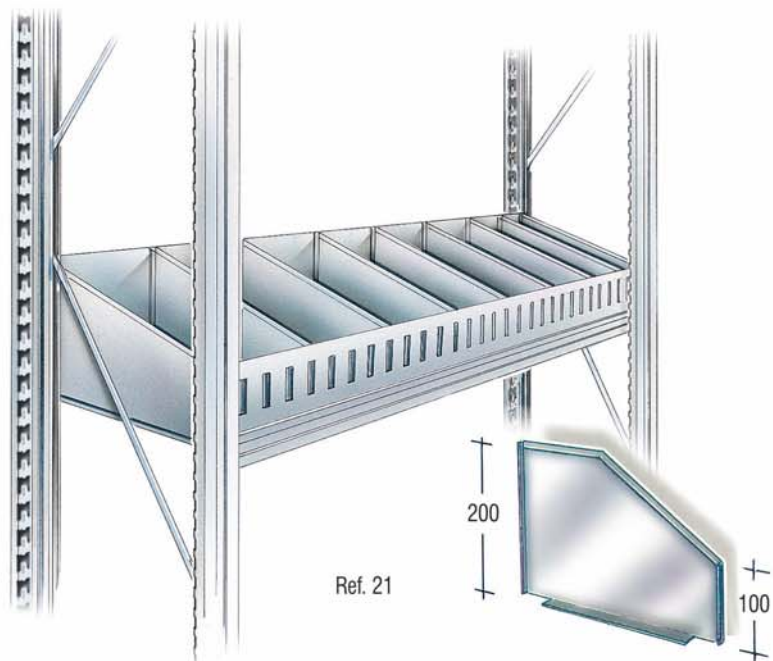
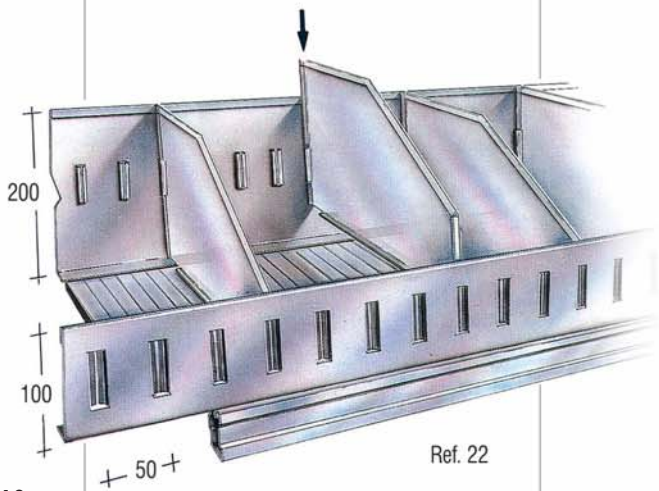
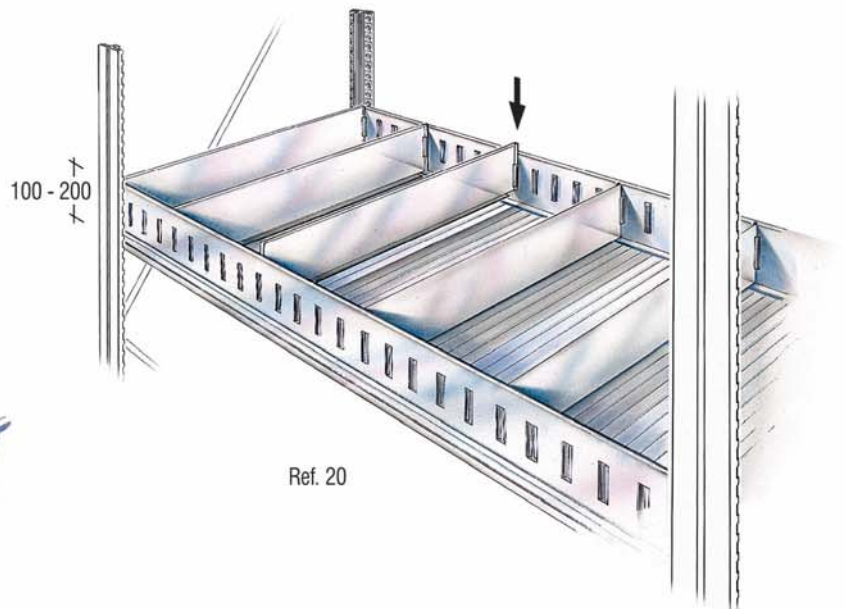



PLASTIC LINE

Open fronted plastic bins are also available for the storage of loose items. More information on page 55.

Fixed Height Dividers

Available in three different heights: 244-344-444 mm. They can be inserted in any position on the shelf by means of spring clips located on the beams H47 (Ref. 23).

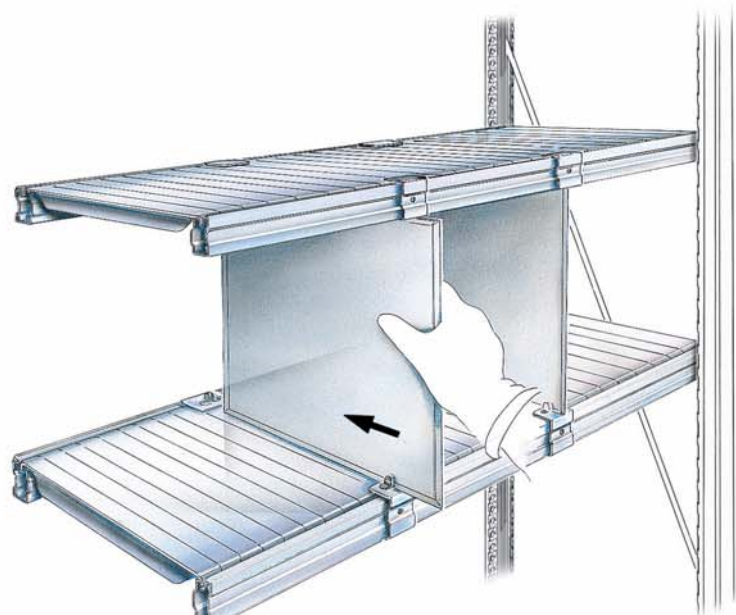
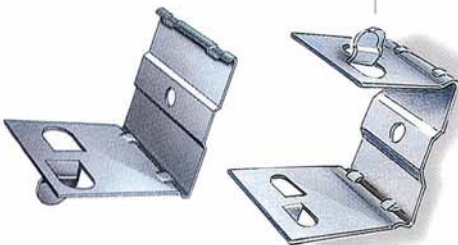

Ref. 23



Ref. 24

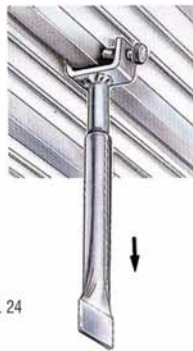

Ref. 25

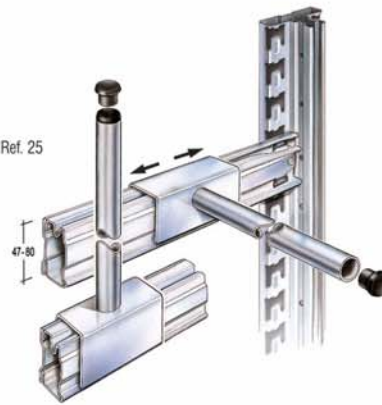

Telescopic Tube Dividers

Used for the separation of cylindrical components or materials difficult to store (windscreens and panels, etc.). They comprise 2 tubes of 18 mm diameter sliding one inside the other. They are fixed to the upper shelf by means of a clamp/screw connection (M8 bolt). A minimum of two tubes should be used for each division (Ref. 24).

Dividers for Exhaust Pipes

Spigots designed for the separation of tubes, exhausts and conduits, etc. Dividers for exhaust pipes are supplied for both vertical and horizontal divisions fitted directly to the beam (not to be loaded) (Ref. 25).



ACCESSORIES

PVC Top Caps

Should always be fitted to the upright top, both when supporting handrails and normal shelves (Ref. 28).

Oval shaped Tubes and Beams

The oval shaped beams and tubes are compatible with most types of hooks and provide a cost effective solution to garment storage and for hanging loads (Ref. 27/28). The garment hanging shelving can be designed on a single or double entry basis and equipped with shelves as well (see pictures).

The oval tubes fitted onto the spacer bars alone will not stabilise the structure in the horizontal plane and have to be combined with beams above and below.



Tyre Storage

The oval shaped beams can also be used for the storage of tyres (see pages 8-9). In this case, please refer to the technical handbook to identify correct use and respective load bearing capacity, as tyre storage introduces dynamic loads into the structure.

In the case that the tyres will be stored on H47 mm beams, it is mandatory to use the USM series for the frames and the Super 3 version of the beams.

Maximum allowed bay length: 1200 mm.

Maximum allowed frame depth 400 mm, to ensure safe storage and prevent torsional deflection of the beams.



Plastic Strip for Glass Shelves

It can be fitted on the beams H47/H80 in order to protect glass shelves or delicate materials (Ref. 29).

Security Pins

In order to prevent accidental lifting of the beams and shelves, the security pins must be used in all applications (Ref. 30). Assembly instructions as per the sketch at right.

Label Holder

It can be located in any position on both H47 and H80 beams. Dimensions 100x40 mm. (Ref. 31).

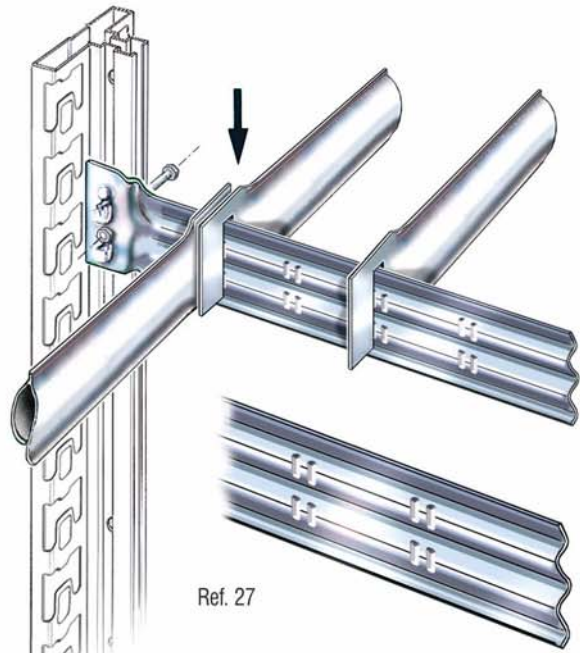

Ref. 27

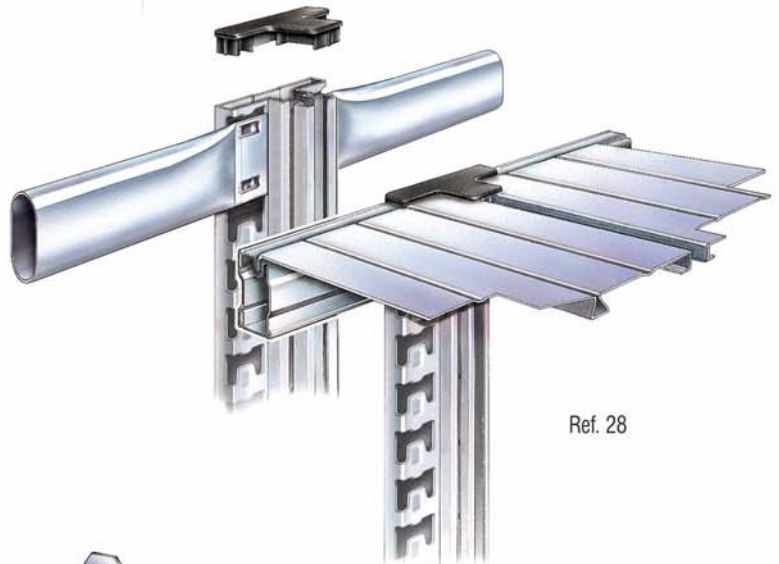

Ref. 28



Ref. 30

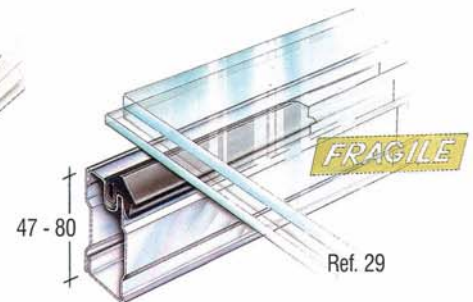

Ref. 29



Ref. 31

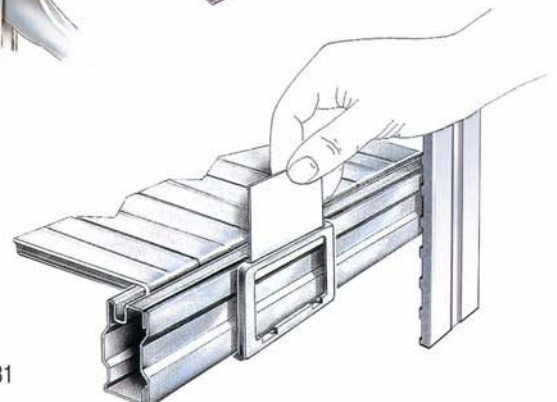

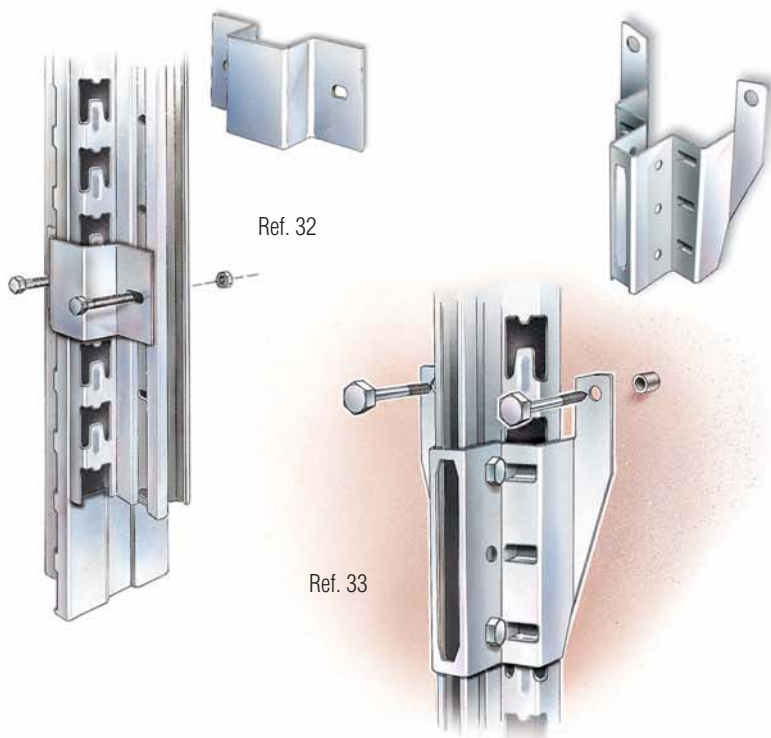

Ref. 32

Ref. 33

Frames back to back Clamps

They are used to fix the frames together when building back-to-back bays to improve stability. They are located at mid height (Ref. 32).

Wall Fastening Brackets

This component (art. n° SLACC131.95) is located by means of two M8x50 anchor bolts (art. n° 00040.20) and two M6x35 nuts + bolts (art. n° 00006.20 + 00020.20), providing a method to fix the frames to a wall for stability (Ref. 33).



Ref. 32

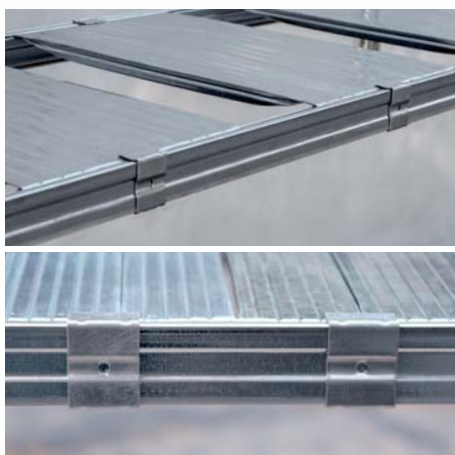

Ref. 66

Fastening Clips for Shelf Panels

These fastening clips are an optional accessory, used to prevent shelf panels from being accidentally unseated from their position. They may also be used as a locking mechanism for the shelf panels to be firmly kept at a given position or at a distance to achieve 50% opening of the surface or alike. The clips press the shelf panels against the beams providing the added benefit of stiffening the entire system. They are assembled by hand and can easily be disassembled with the aid of a flat-bladed screwdriver (Ref. 66). Please refer to METALSISTEM Informa n° 672 for additional information.

BACK CLADDING

BACK CLADDING PANELS H12 for back-to-back Bays

Back panels H12 are manufactured in 450-600-900 mm standard width and in standard heights of 1485-1940-2480-2980 mm. When using H-12-mm back panels within back-to-back bays, the single modules are superposed at the centre of the bay (see sketch on page 25). The cladding modules are kept in position by the beams of the back-to-back bays. For multiple cladding heights, a couple of beams has to be located at junction points.

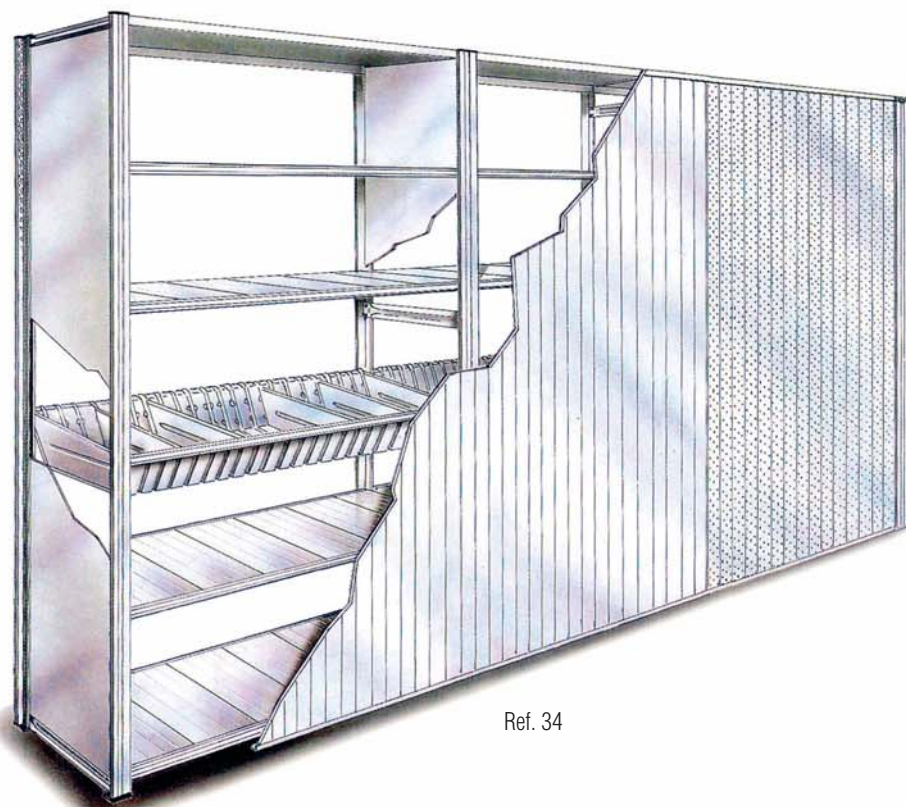

Ref. 34

BACK CLADDING PANELS H29 for single sided rows

Back cladding for single sided rows is made from H29 cladding panels (Ref. 34/38). These cladding panels are located length the front face of the uprights in a shelving row and finished off with upper "U"-profiles (art. n° 69801.95, Ref. 38). "H"-shaped channel profiles (art. n° 69804.95 - Ref. 38) may be used as middle joints to connect the cladding panels in height.

The single cladding panels are connected to each other by means of M6x20 bolts and fastened to the beams of the shelving row by means of fastening clamps (art. n° 69862.98 - Ref. 54).

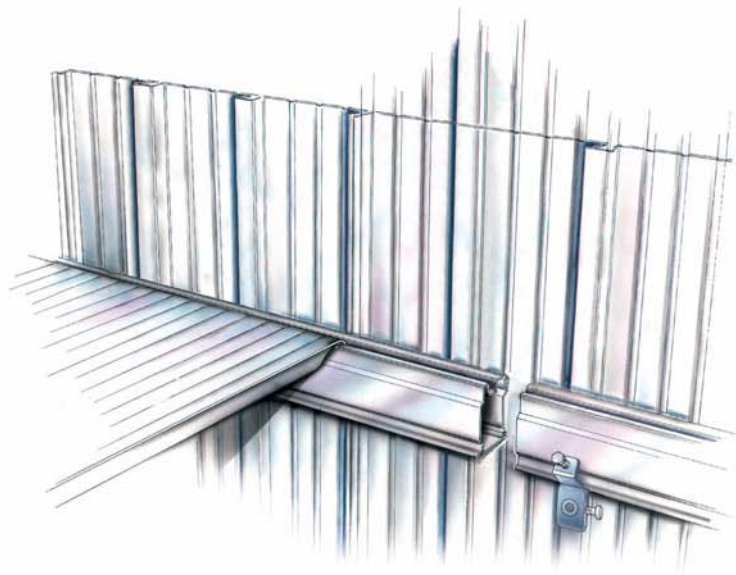

Ref. 35

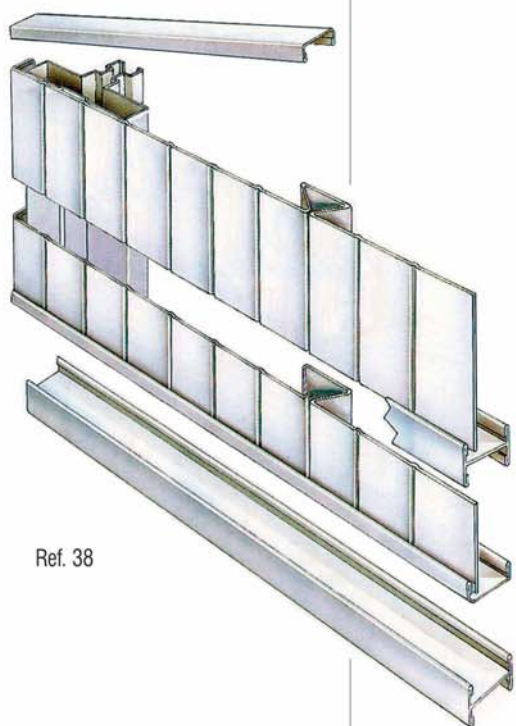

Ref. 38

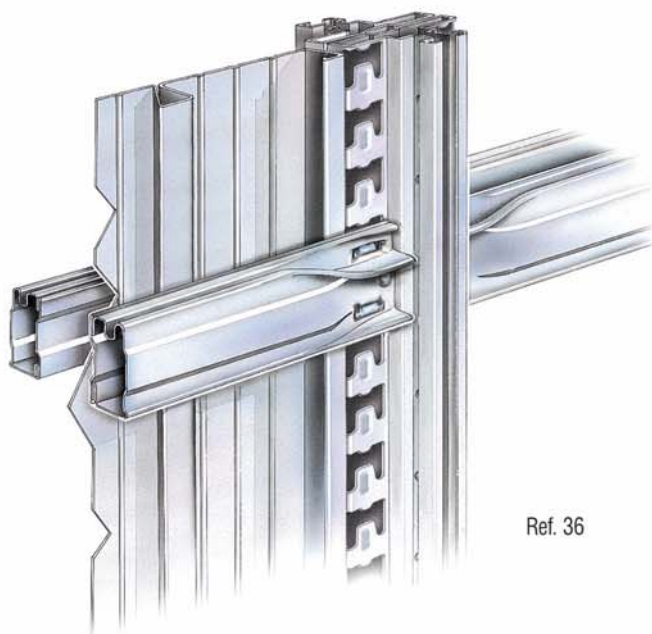

Ref. 36





Ref. 37



Ref. 39

Side and End Frame Cladding

This type of cladding is produced in heights 1368-1468-1868-2368-2468 mm for all frame depths. Thus, side and end frame claddings of any dimensions can be provided as per the diagram shown below. Fixing is made by means of M6x10 screws (Ref. 37).



FRAME AND INTERMEDIATE CLADDINGS – Assembly diagram

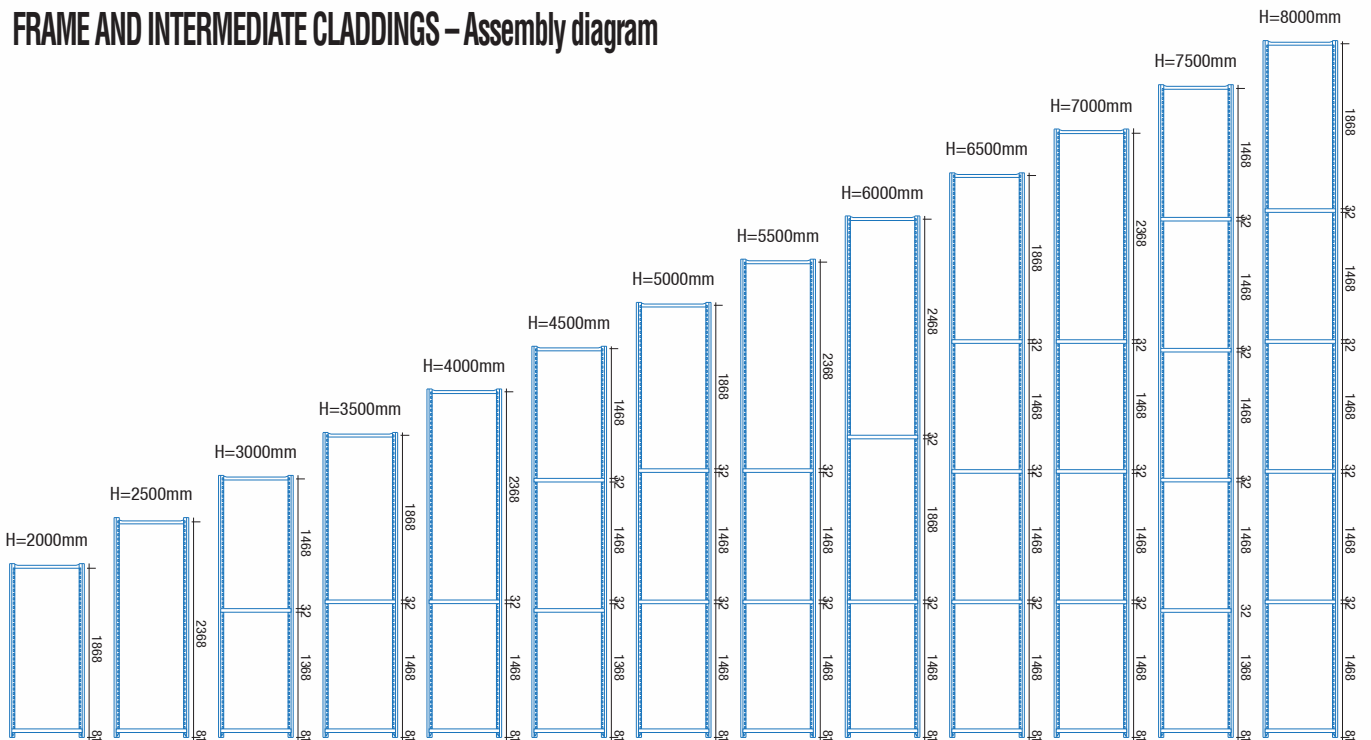

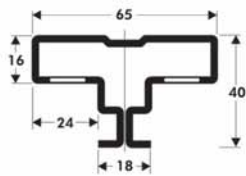

UPRIGHT SECTION
SERIES USA - USB - USM

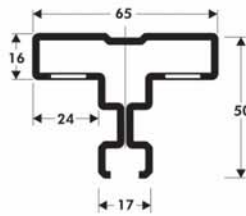

UPRIGHT SECTION SERIES USR

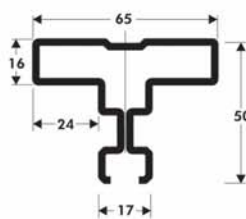

UPRIGHT SECTION SERIES USP
to locate H30 solid shelves



The sketches shown below explain the make up and assembly of cladding. They can be used in conjunction with H47/H80 beams only.

BACK CLADDING PANELS H29 for single sided rows

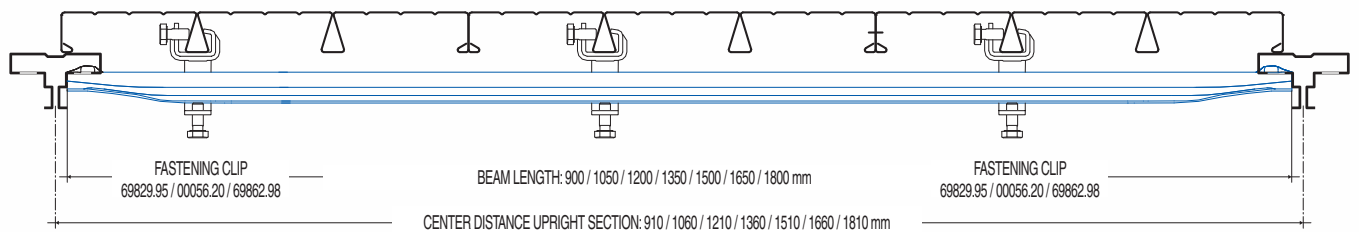

BACK CLADDING PANELS H12 for back-to-back bays

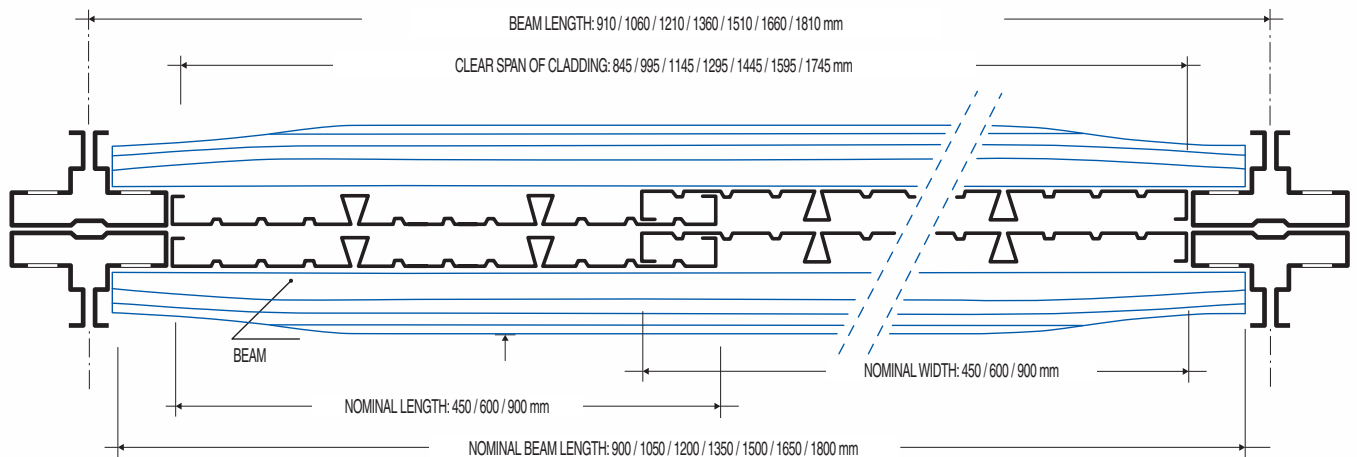

TWO TIER STRUCTURES WITH SUSPENDED WALKWAYS USM-USR (max. load bearing capacity=300 daN/m²)

Two tier structures, even varied and complex have been designed and perfected by METALSISTEM.

Two tier structures up to a height of 8000 mm can be designed.



When designing two tier structures, always refer and adhere to the calculation and safety code summarized on pages 4-5 of this brochure.

Max. shelf bay length: 1500mm
Max. walkway width: 1200 mm

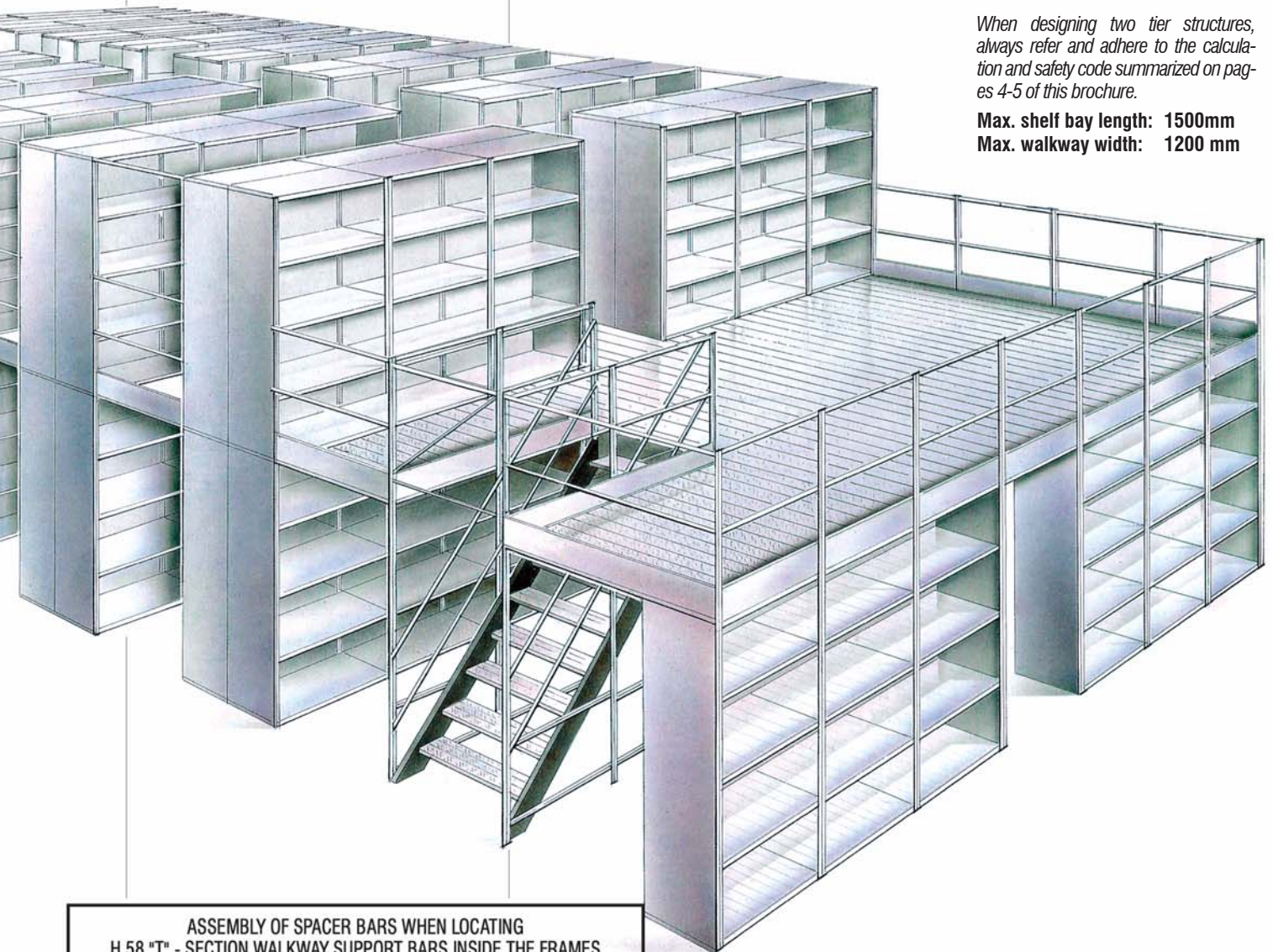

ASSEMBLY OF SPACER BARS WHEN LOCATING H 58 "T" - SECTION WALKWAY SUPPORT BARS INSIDE THE FRAMES

L 900 : NO SPACER BAR

L 1200 : ONE SPACER BAR AT THE CENTRE

L 1500 : ONE SPACER BAR AT THE CENTRE

- NOTE:**
- The spacer bars connecting the "T"-walkway support bars must be ordered in a special length (10 mm narrower than those used to assemble the standard frame).
 - When building staircases, customers should fit one spacer bar under each stair tread.
 - The load bearing capacity of the H58-T-section walkway support bars are stated in the technical addendum.

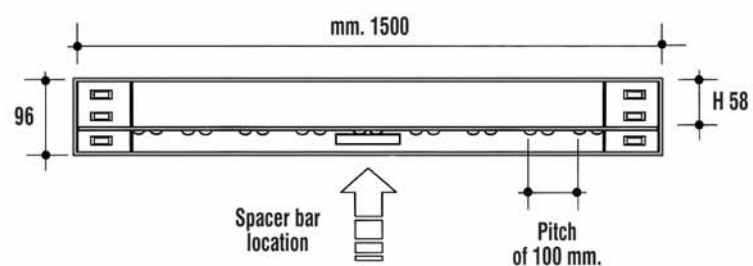

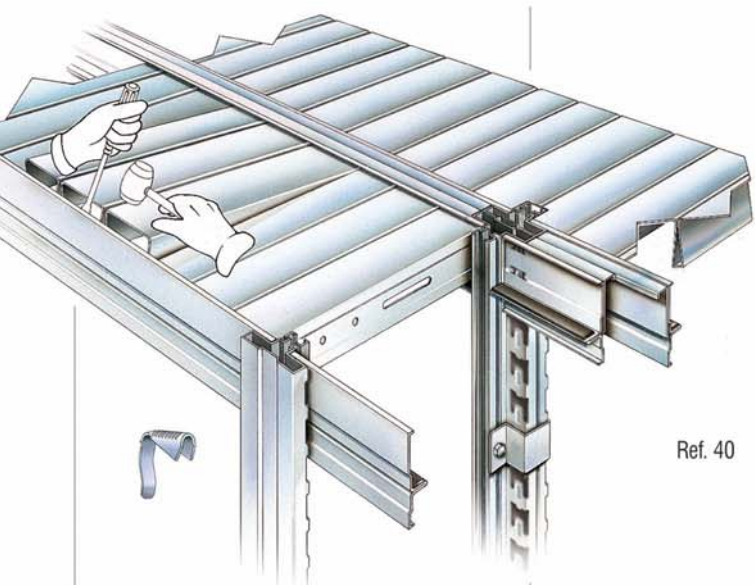

Ref. 40

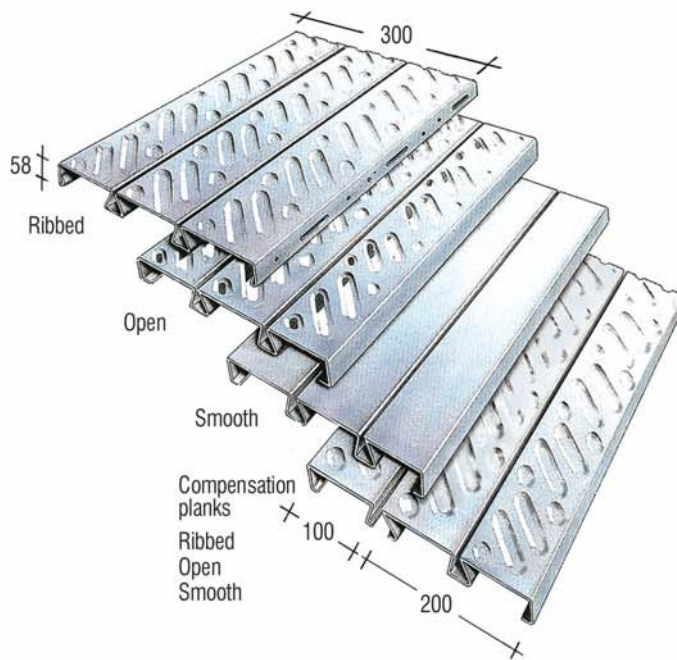

Steel Planks

These can be supplied with three different surfaces: ribbed, open and smooth, together with compensation panels and fastening components. The steel planks are inserted into the "T-Section" supports by levering between the panel and the support (Ref. 40).

There are two types of steel planks: one for walk-through bays and one for walkways. When ordering, always refer to the length of the respective spacer bar used for building the walkway or the frames. It is mandatory to use the "T-Section" support bar safety clip (art. n° SLACC003.95).

"T-Section" Support Bracket - at 90°

"T-Section" support bars can be located at 90° by assembling one half of a wall fastening bracket (art. n° SLACC131.95) and one half of a "T-section" support bracket (art. n° SLACC130.95) (Ref. 41).

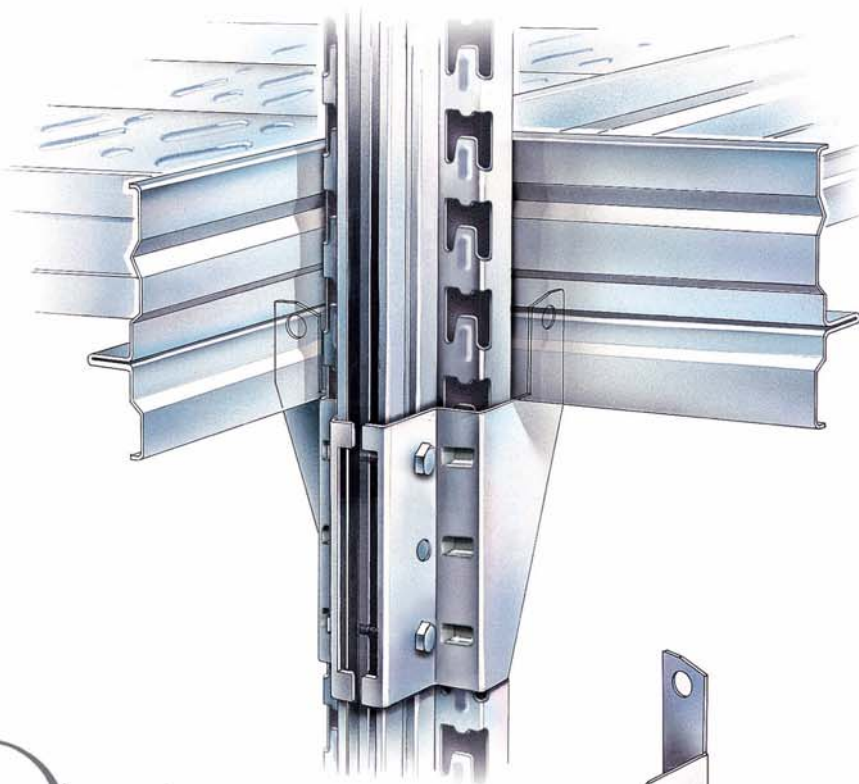

Ref. 41

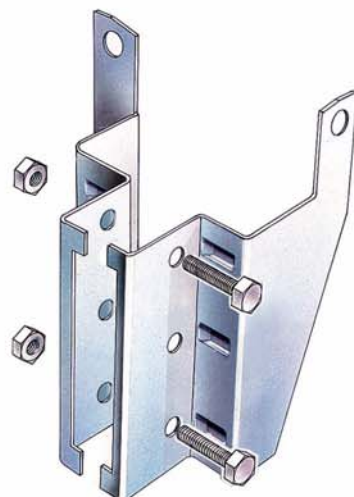
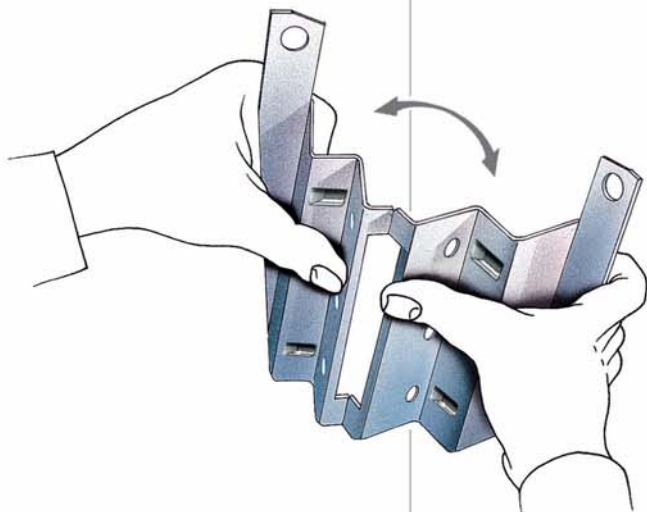

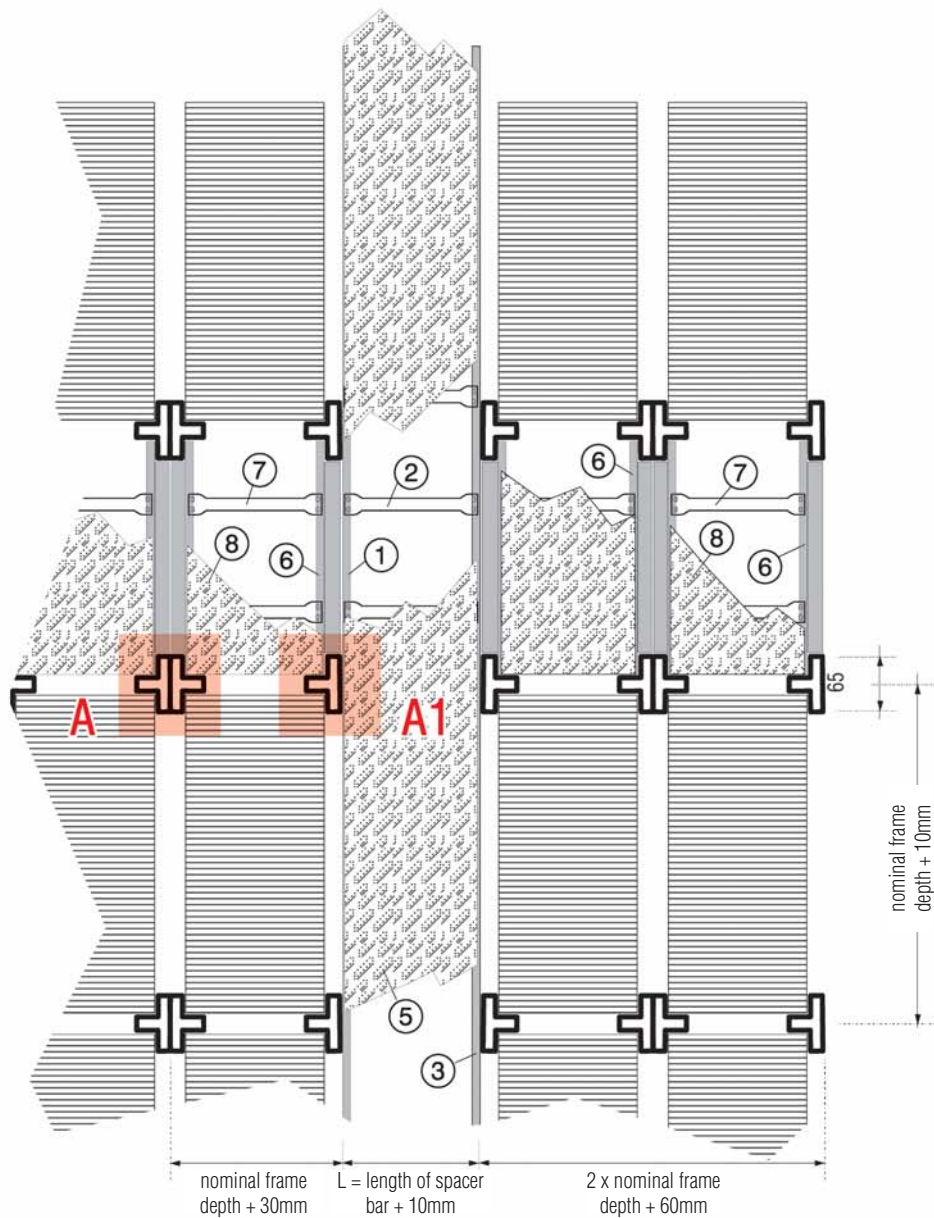

CONFIGURATION ...where intersecting aisles combine with main walkways.

ID	Article nr.	Description
1.	67015.95	T-section support bar H58 - walkway
2.	99044.95	Spacer bar - special length L=length of walkway - 10 mm
3.	SLACC130.95	Support bracket Unirack for T-section support bar
	00003.20 + 00029.20	Screw + self-locking nut M6x30
4.	69829.95+00056.20+69861.98	Clamp and bracket for beams up to 20 mm
5.	69707.95	Steel planks H58 "walkway" L=length of special spacer bar (see ID - nr. 2)
6.	SLACC222.95	T-section support bar H58
	SLACC224.95	inner frames
	SLACC226.95	
7.	99044.95	Spacer bar - special length L=nominal frame depth - 10 mm
8.	69704.95	Steel planks H58 "inner frames" L=nominal frame depth
9.	67021.98	Noise dampening strip
10.	SLACC003.95	Security Pin

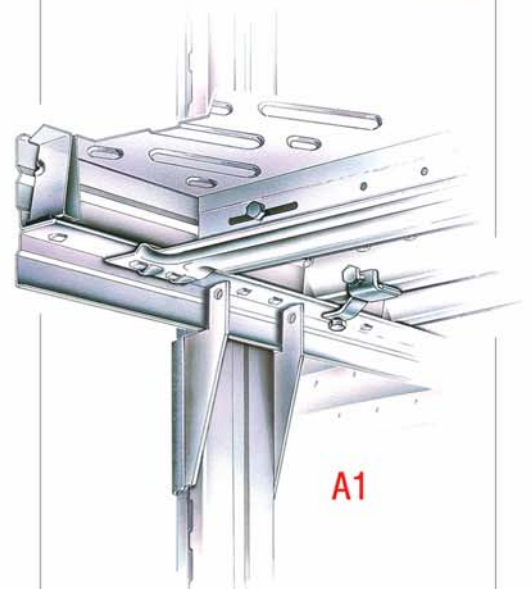
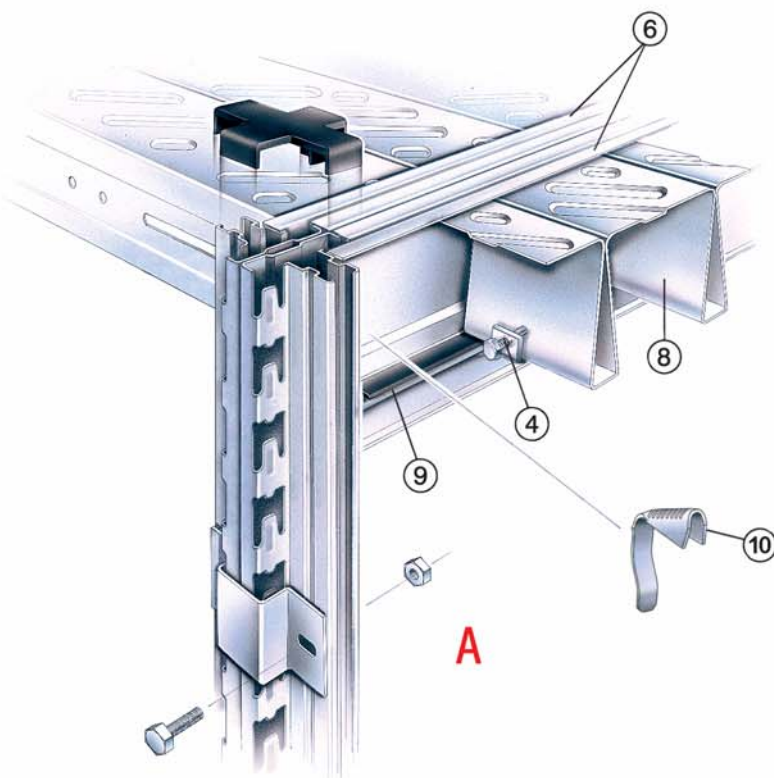

CONFIGURATION ...where intersecting aisles meet with walkways at 90°.

ID	Article nr.	Description
1.	67015.95	T-section support bar H58 - walkway
2.	99044.95	Spacer bar - special length L=length of walkway - 10 mm
3.	SLACC130.95	Support bracket Unirack for T-section support bar
	00003.20 + 00029.20	Screw + self-locking nut M6x30
4.	SLACC130.95	Half of the Unirack support bracket
5.	SLACC131.95	Half of the Unirack wall fastening bracket
6.	69829.95+00056.20+69861.98	Clamp and bracket for beams up to 20 mm
7.	69707.95	Steel planks H58 "walkway" L=length of special spacer bar (see ID - nr. 2)
8.	67021.98	Noise dampening strip

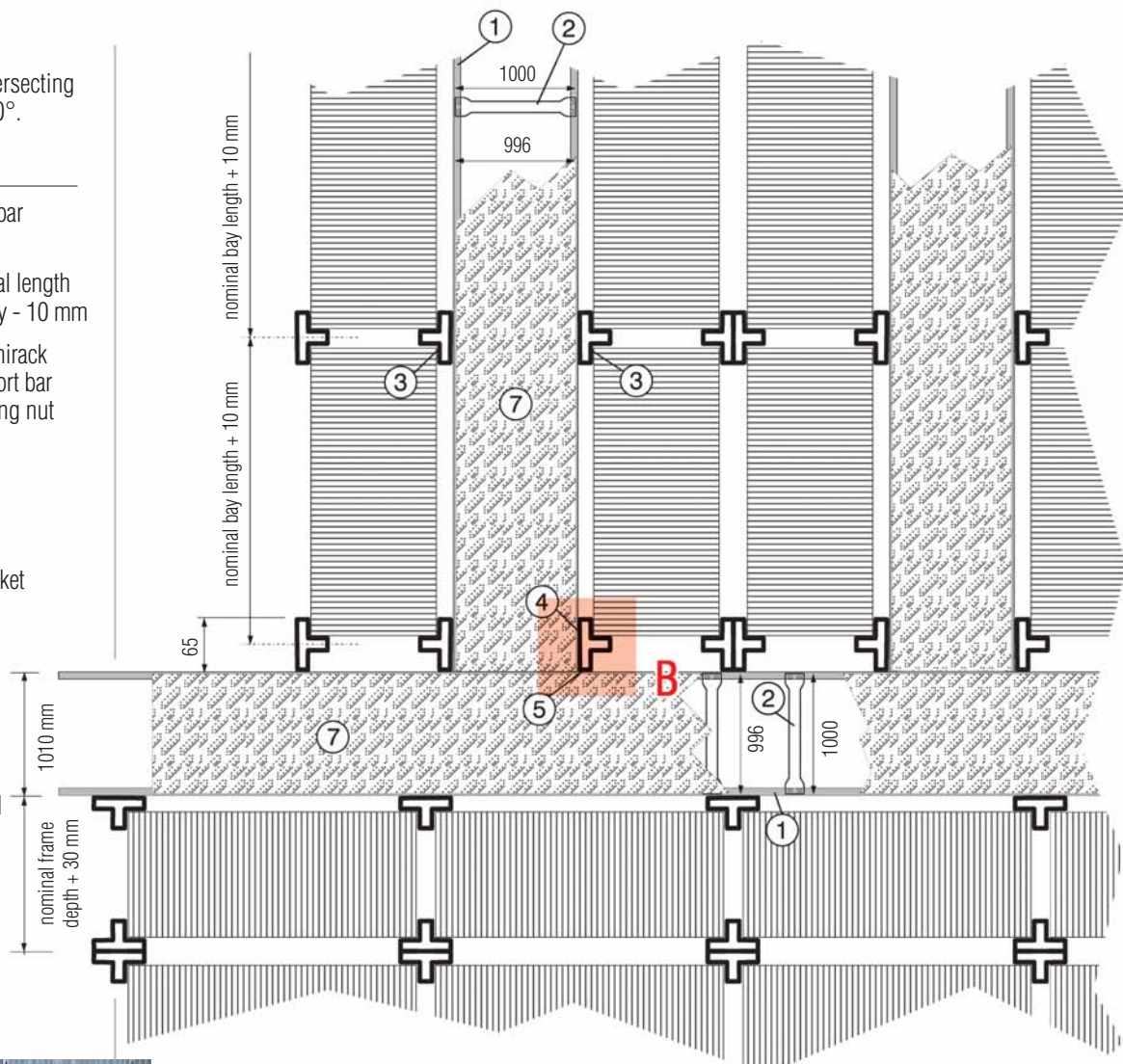

Modular Sliding Gate

The modular METALSISTEM sliding gates are supplied preassembled.

Two version are available:

- with guide rail on ground;
- with suspended guide rail.

The guide rail for the sliding gate is made from a USP-upright profile supplied in standard lengths of 4500 mm which may be cut to size on site according to individual needs.

For available dimensions and ordering, please refer to page 51.

Example:

1010 mm = width of walkway

1000 mm = length of spacer bar of walkway

996 mm = real length of steel planks for walkway (when ordering please specify the dimension of the spacer bar used to build the walkway).

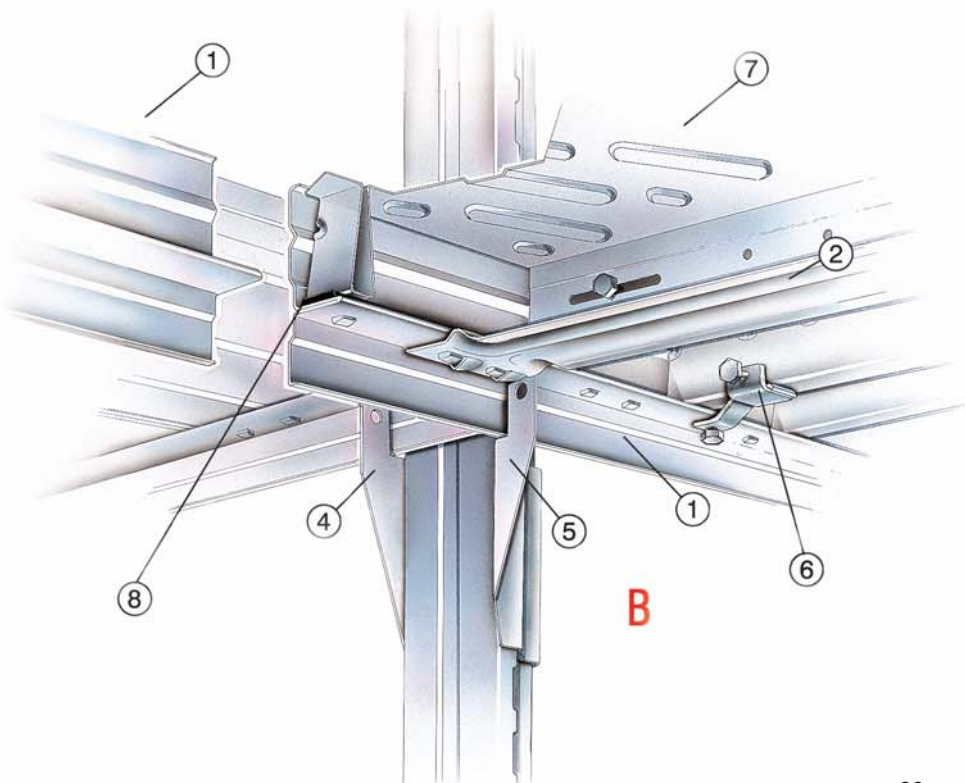

Assembly Instructions Two-Tier Structures

The "T-section" support bracket used for two tier structures makes construction very easy and rapid. It is located onto the uprights by M6x30 bolts & nuts (Ref. 42).

Assemble the "T-section" support bars by fitting spacer bars (art. n° 99044.95) underneath, at approximately 800mm centres. When ordering, the length of these spacer bars should be indicated referring to the overall width of the walkway -10 mm.

A noise dampening adhesive strip is fitted onto the "T-section" support bars, beneath the walkway panels.

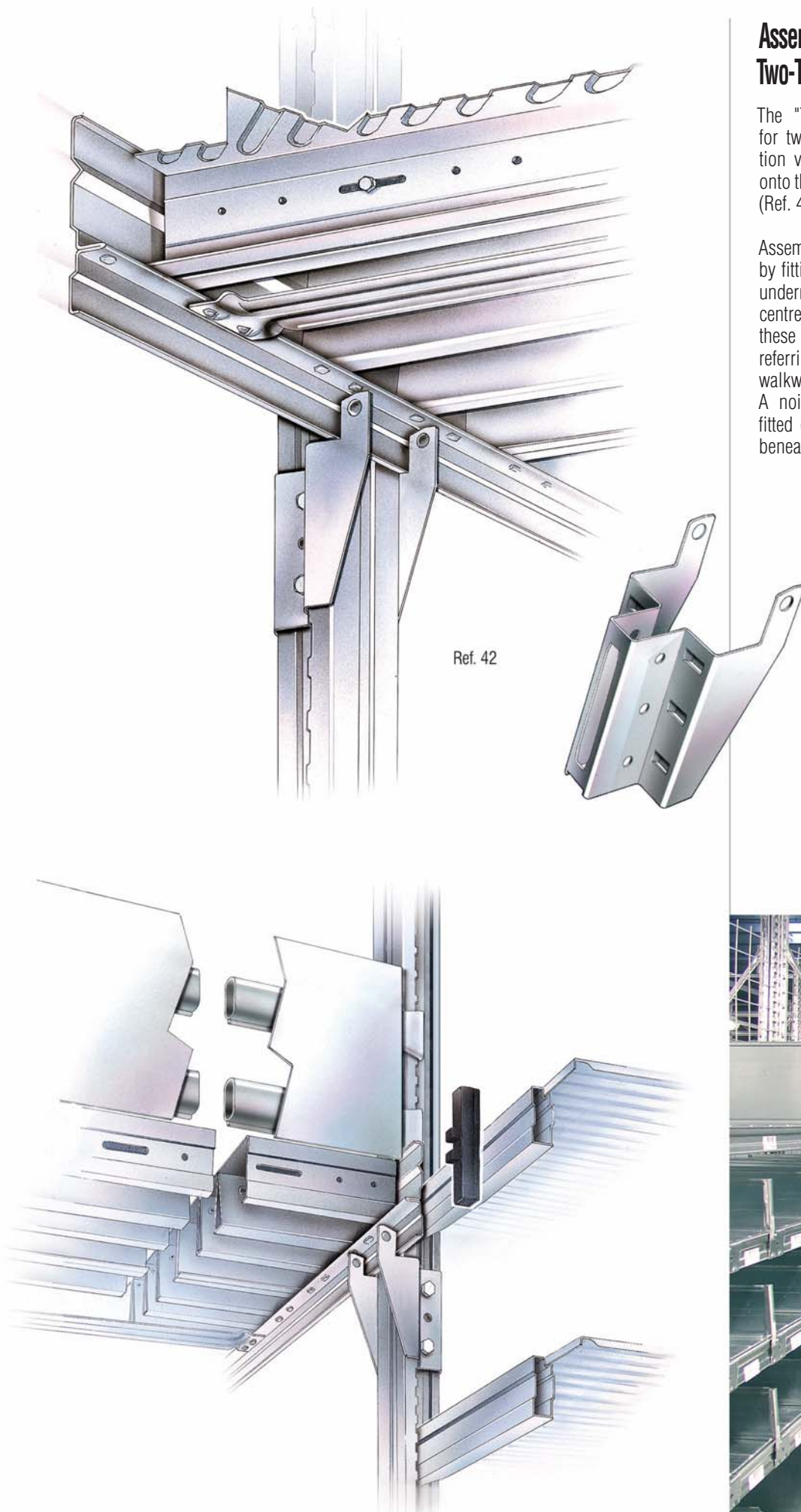

Ref. 42



Handrails and Kickboards

Handrail, knee rail and kickboard dimensions are specified at project design stage (Ref. 43).

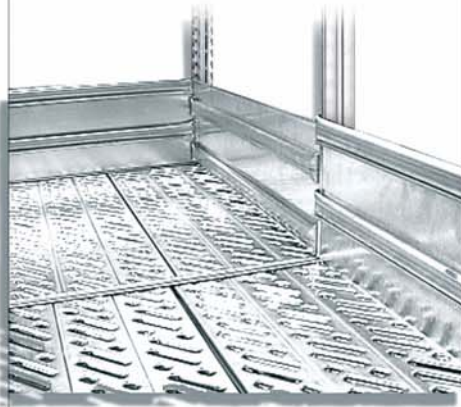

Kickboards

Three different types of kickboards are available: for use in the direction of the beams, at the end of a run within uprights, or for walkway ends.

Kickboards are made from two oval shaped tubes (the same used to build the handrails) fixed to the uprights and finished off with a metal sheet element located onto the oval shaped tubes by self tapping screws.

For correct ordering of these items and dimensions, please see instructions on page 51 of this brochure. The use of beam retaining clips is mandatory.

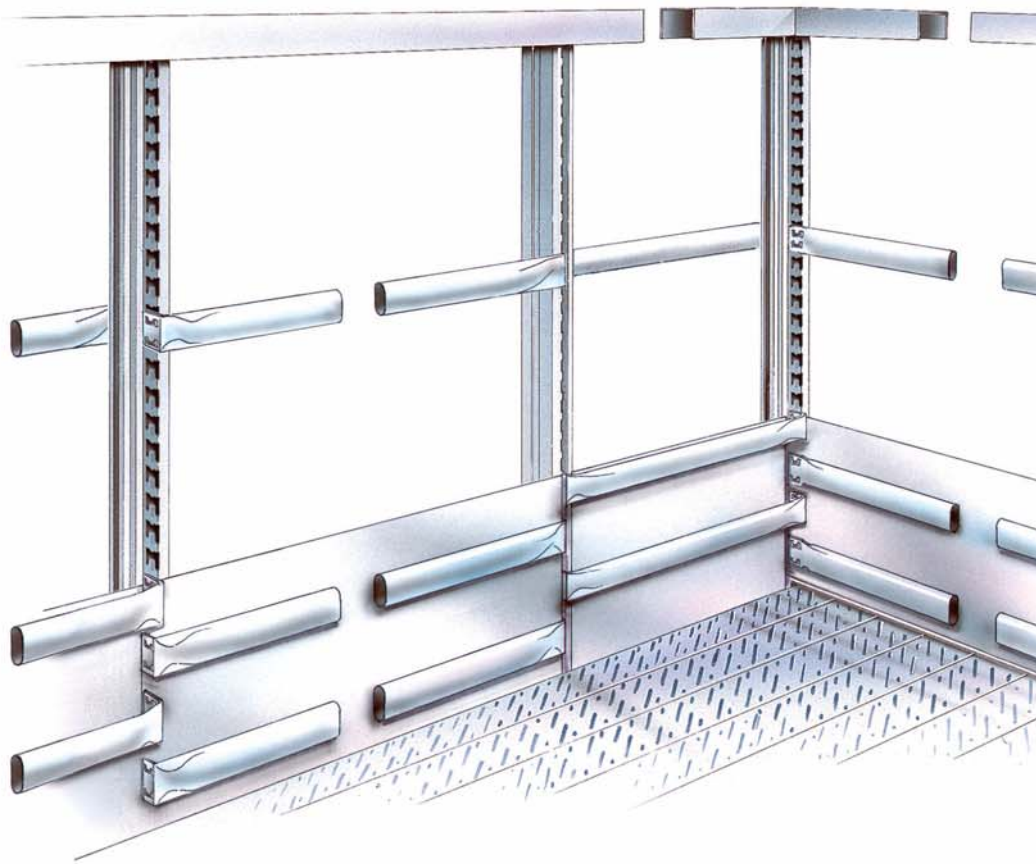

Ref. 43

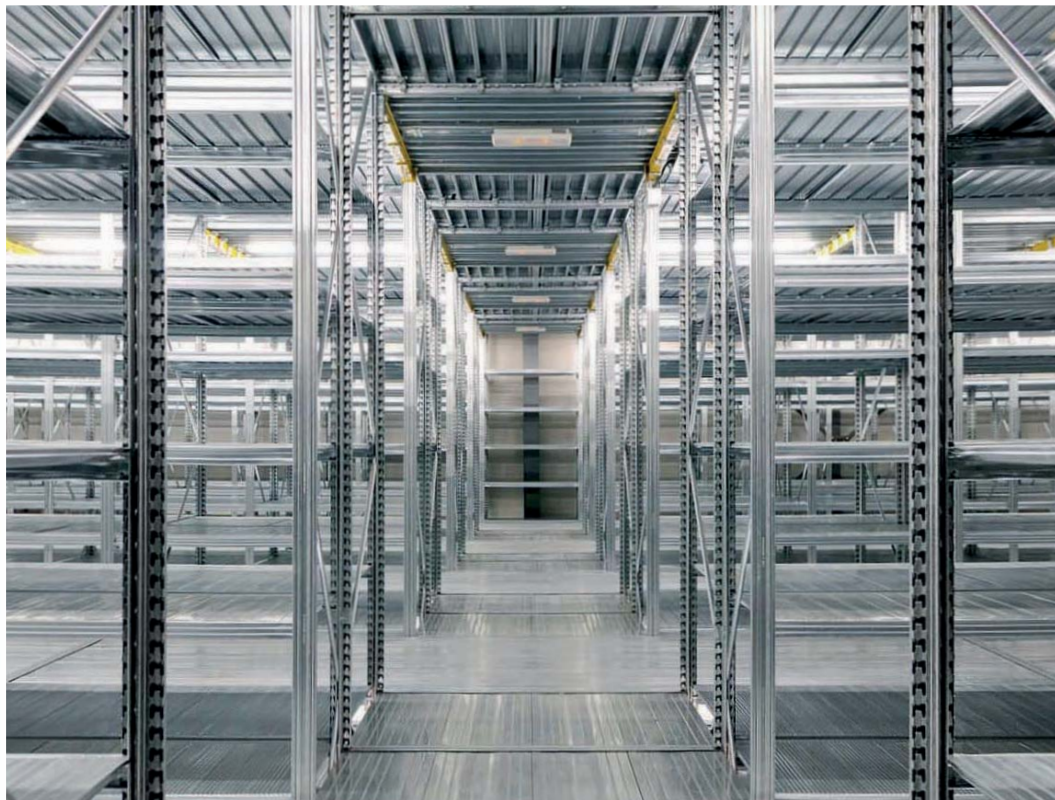

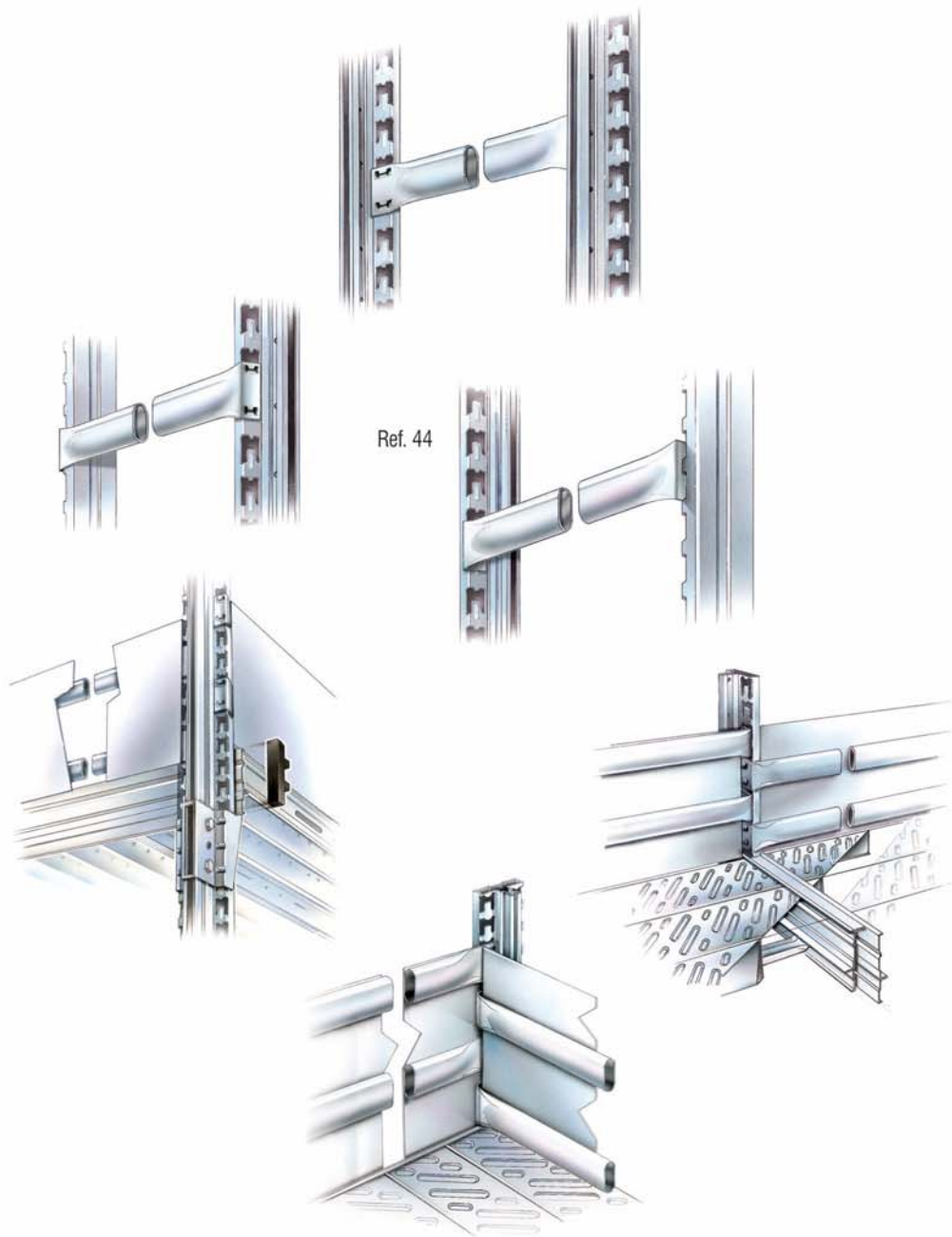

Handrails

The handrails made from oval shaped profiles (Ref. 44) are assembled as follows:

- n° 1 tubular handrail;
- n° 1 tubular kneerail;
- n° 1 kickboard, made from two oval shaped profiles and finished off with a metal sheet element fastened onto these profiles.

The use of beam retaining clips is mandatory.



art. n° 36501.95 - 36510.95



art. n° 67402.95



art. n° SLACC118.95

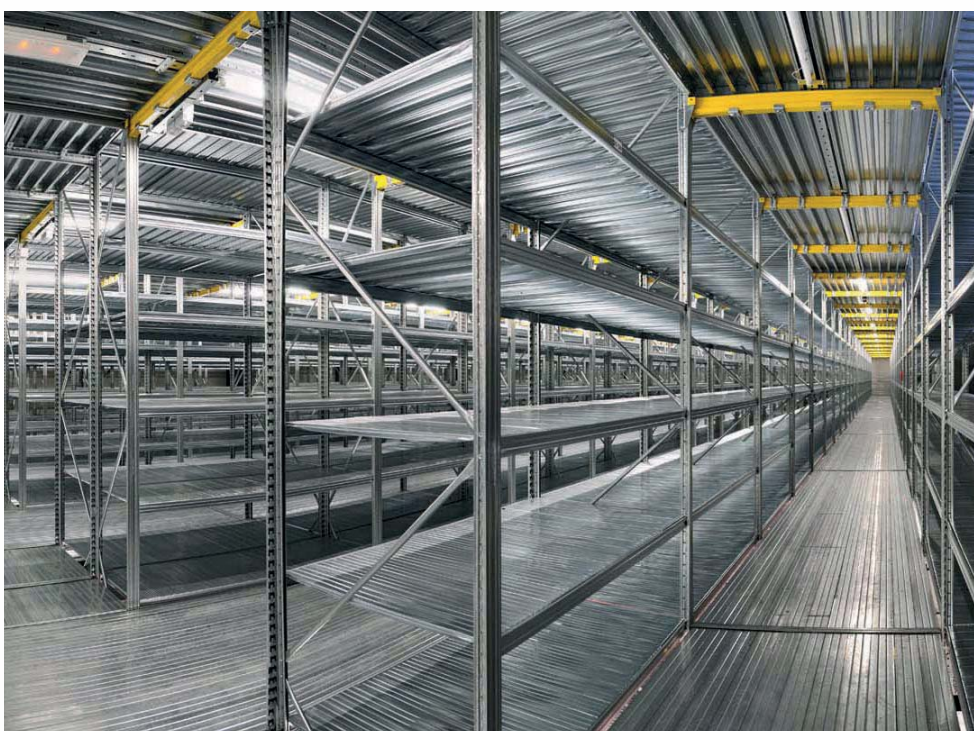

When ordering, customers should pay attention to the following instructions and indicate:

- the length of the special spacer bar of the walkway, when ordering art. n° SLACC118.95 (for example: overall width of walkway 1010 mm, length of spacer bar and handrail 1000 mm);
- the nominal frame width, when ordering art. n° 67402.95;
- the nominal bay length, in case of art. n° 36501-36504-36507-36510.95.

For correct ordering of these items, please also refer to page 51 of this brochure.

As an alternative to the oval shaped profiles, "U"-section profiles are available as well (Ref. 48).

The "U"-section profiles, 68 mm wide (art. n° 69808.95) come in a standard length of 4000 mm and are assembled in conjunction with special PVC supports (art. n° SLACC076.98 - SLACC077.98 - SLACC078.98).

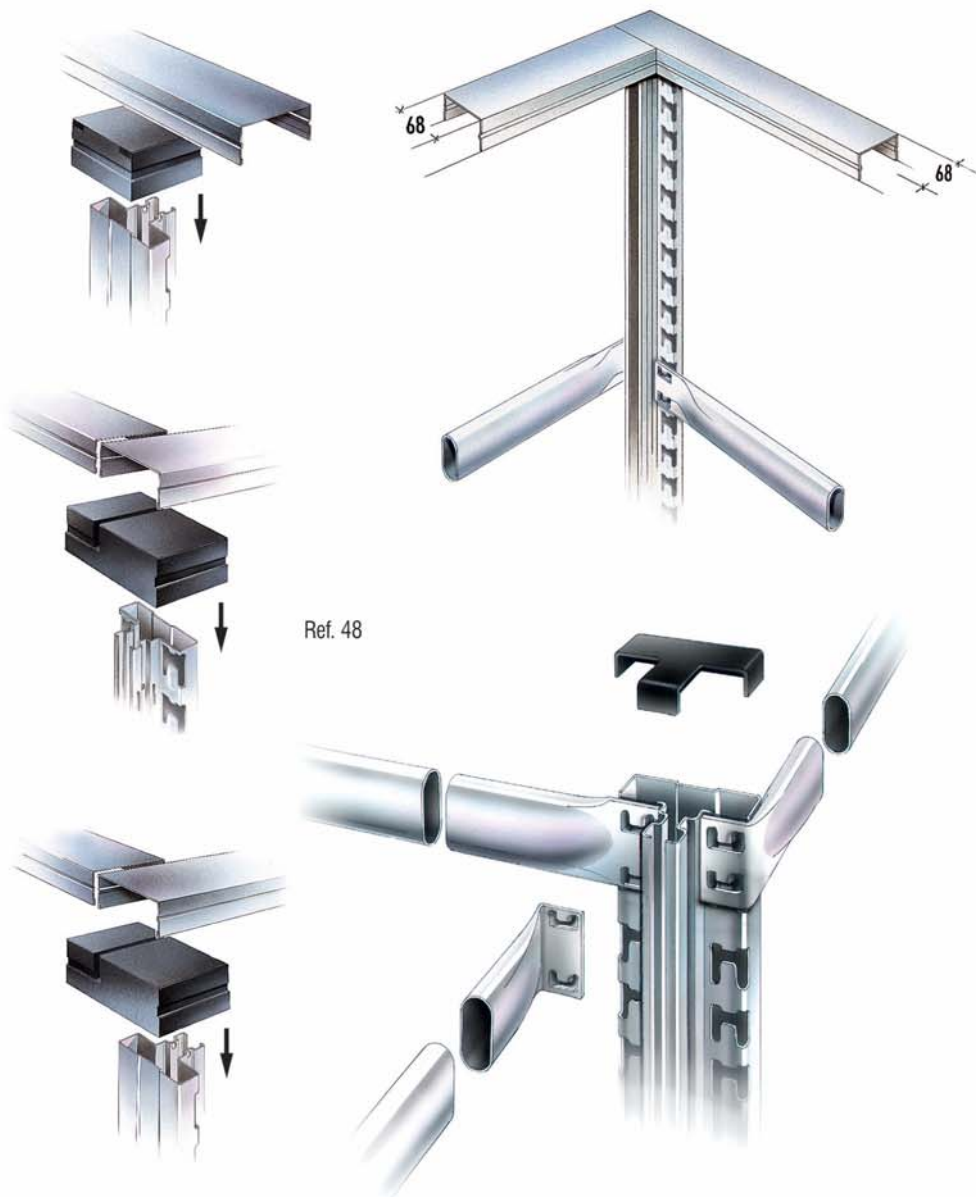

Staircase Handrail

The handrail tube is a square profile in \varnothing 32x32 mm section, available in both stainless steel and zinc coated version.

The fastening of the handrail onto the up-rights is made by nylon components and brackets, as shown in the picture at right (Ref. 45).

The necessary components have been included into a macrocode, for easy ordering.

Please refer to page 53 of this brochure.





STAIRCASES

These can be built using standard components. The length of the stair treads is specified as a steel plank "inner frame" with a dimension between uprights (i.e. the nominal frame depth).

The stair treads are made from anti slip steel planks and are to be fixed with four clamps/screws each (art. n° 69829.95 + art. n° 00056.20).

To improve the stability and load bearing capacity of the staircase, the "T" section beams H58 should be assembled by fitting one spacer bar under each stair tread. These spacer bars will be 10 mm narrower than those used to assemble normal standard frames.

Staircases are to be designed exclusively with reinforced USR uprights (art. n° USR0--/R.95).

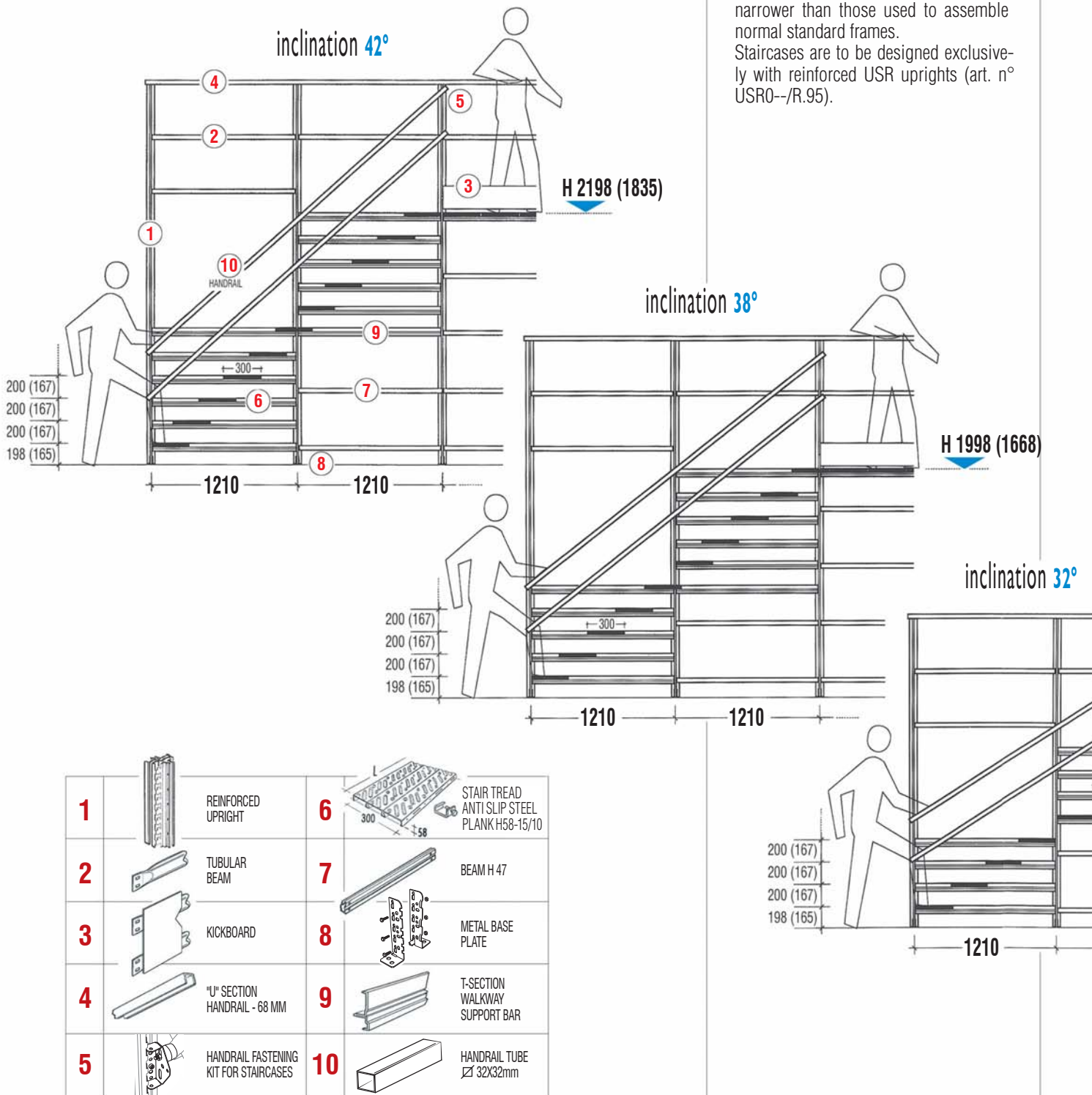

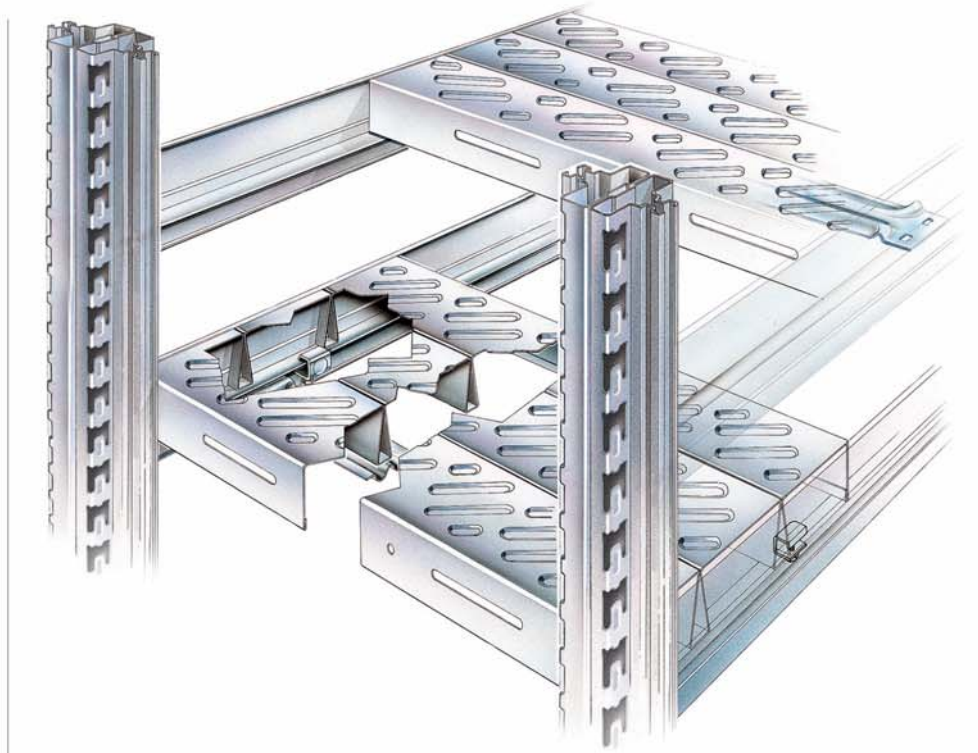
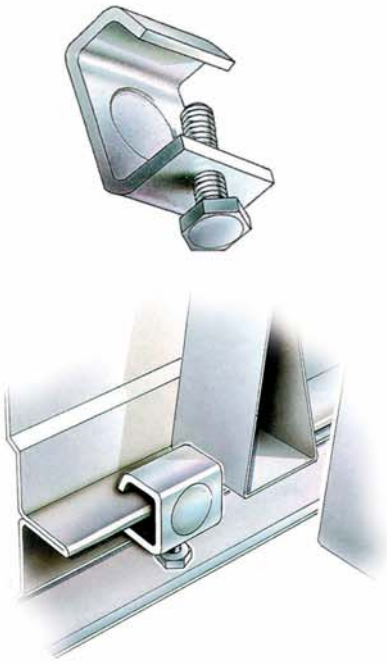

Additional reinforcing profiles must be used on either side of the staircase, i.e. for uprights that are not supported by frame bracing. It is recommended to continue with the regular frame bracing pattern within the frames, as soon as possible.

Welded staircases are also available, to suit any requirement.

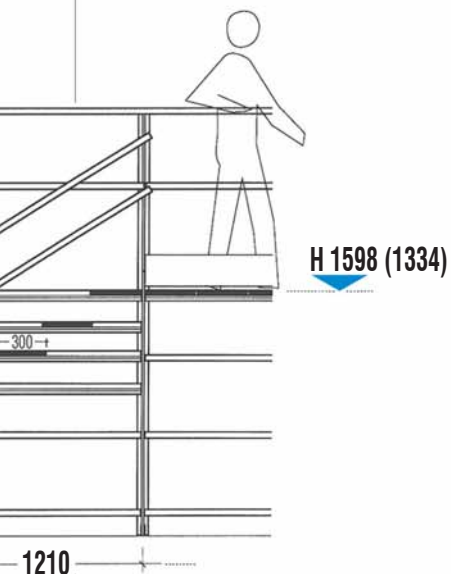

CONFIGURATION ...where intersecting aisles meet with continuous steel decking.

ID	Article nr.	Description
1.	67015.95	T-section support bar H58 - walkway
2.	99044.95	Spacer bar - special length L=length of walkway - 10 mm
3.	SLACC130.95	Support bracket Unirack for T-section support bar
	00003.20 + 00029.20	Screw + self-locking nut M6x30
4.	69829.95+00056.20+69861.98	Clamp and bracket for beams up to 20 mm
5.	69707.95	Steel planks H58 "walkway" L=length of special spacer bar (see ID nr. 2)
6.	SLACC222.95	T-section support bar
	SLACC224.95	Inner frames
	SLACC226.95	in double-version (see sketch)
7.	67015.95	T-section support bar H58 walkway
8.	67021.98	Noise dampening strip
9.	69701.95	Steel planks H58 - continuous steel decking
10.	69829.95+00056.20+69863.95	Clamp and bracket for beams up to 60 mm

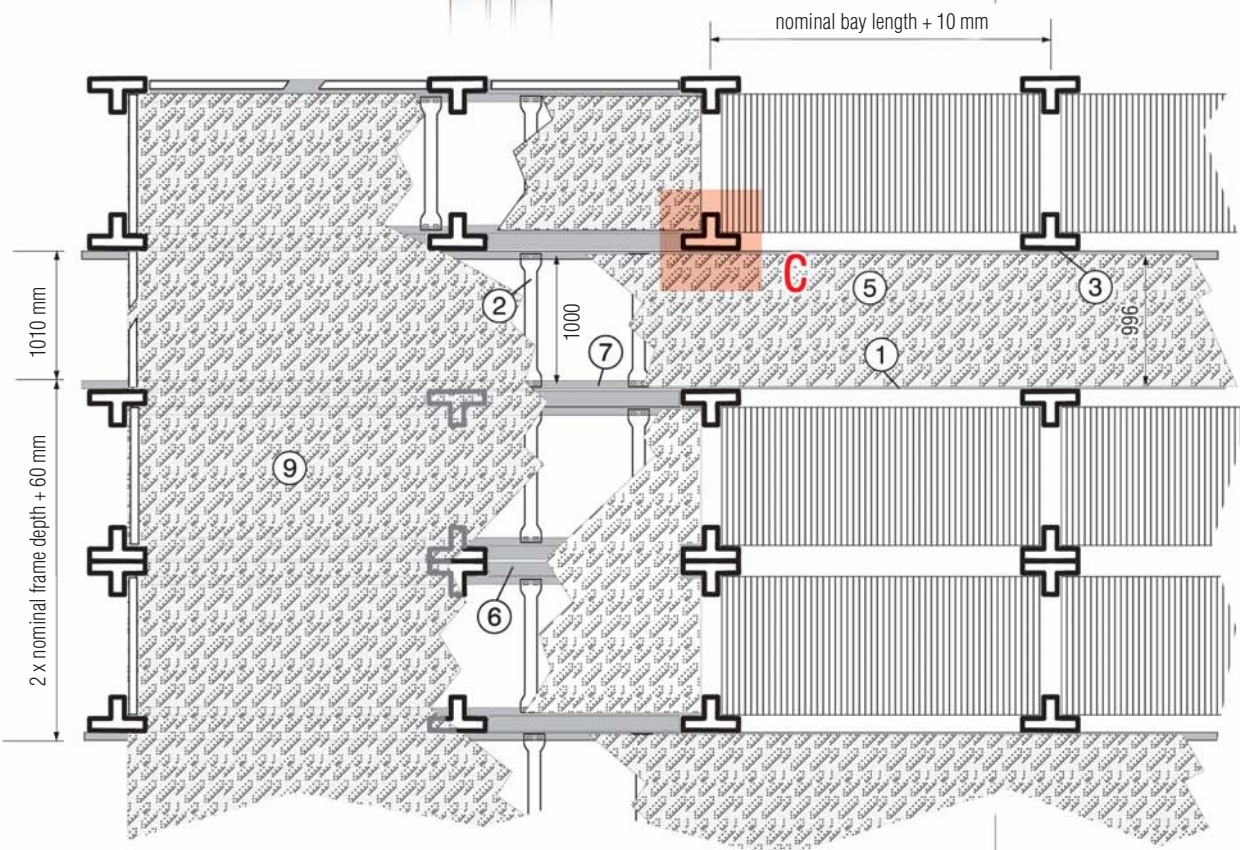
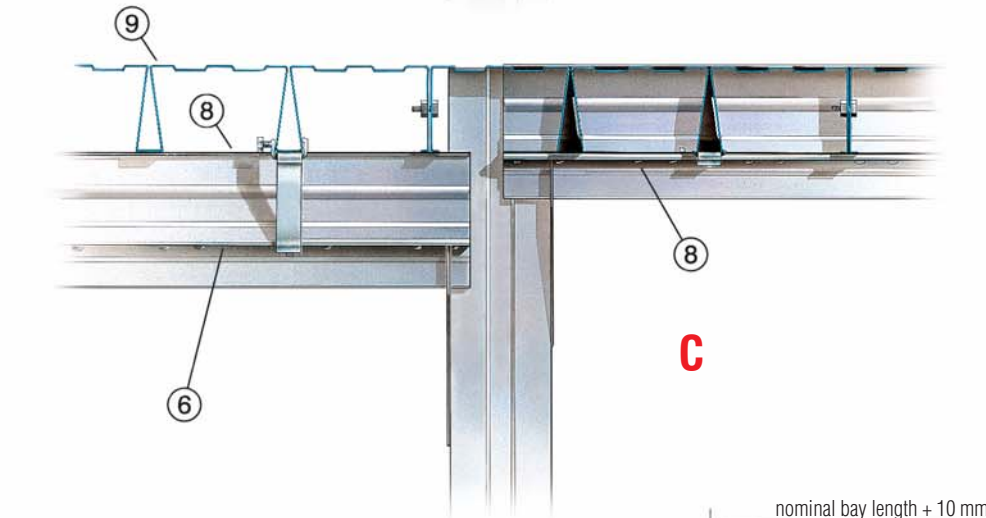
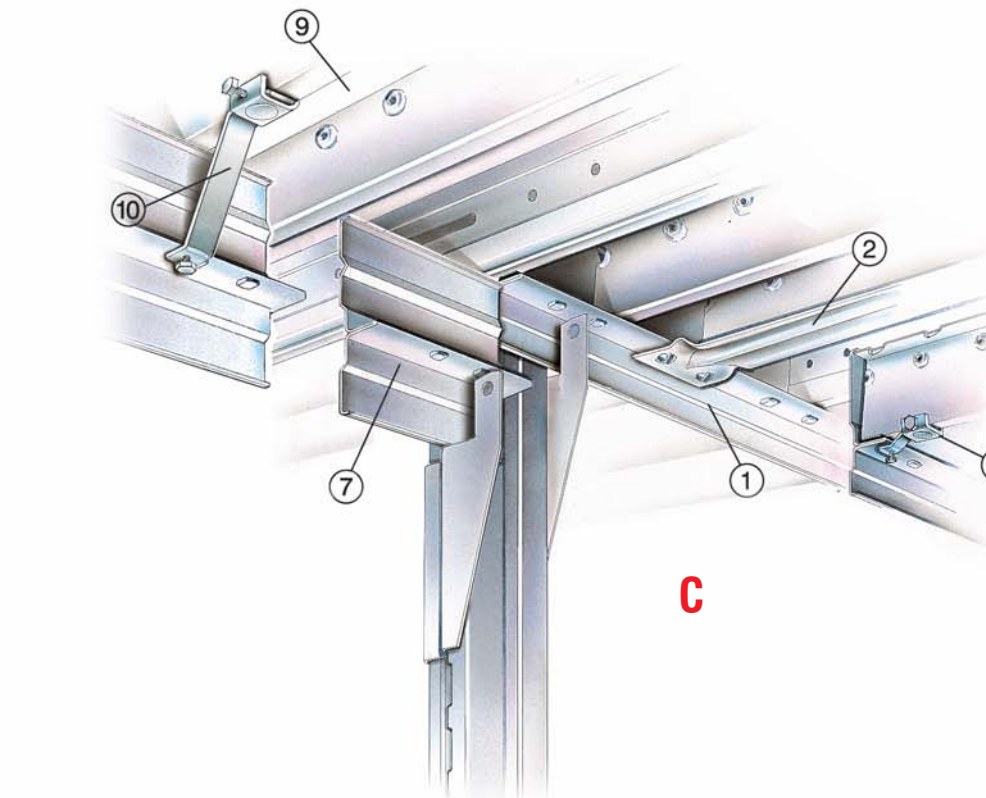

Steel Planking

"T"- section support bars H58 can be used as support beams for the steel planking (Ref. 52). Floors of any dimension can be built in conjunction with "H" joints and "U" section channels. They are used as end and middle joints (Ref. 52/53). The "T-Section" supports are fitted back-to-back. One is fitted on the outside of the upright by means of support brackets, and the other is fitted inside and onto the upright. The steel planks are laid over the top and are fixed down by means of the special clamp (Ref. 51/54). The joining piece (art. n° 69813.95) with two M6x35 bolts (art. n° 69816.98) is used to connect the planks in a longitudinal direction. When joining the planks in a transverse direction, the M6x20 bolts should be used in the appropriate holes.

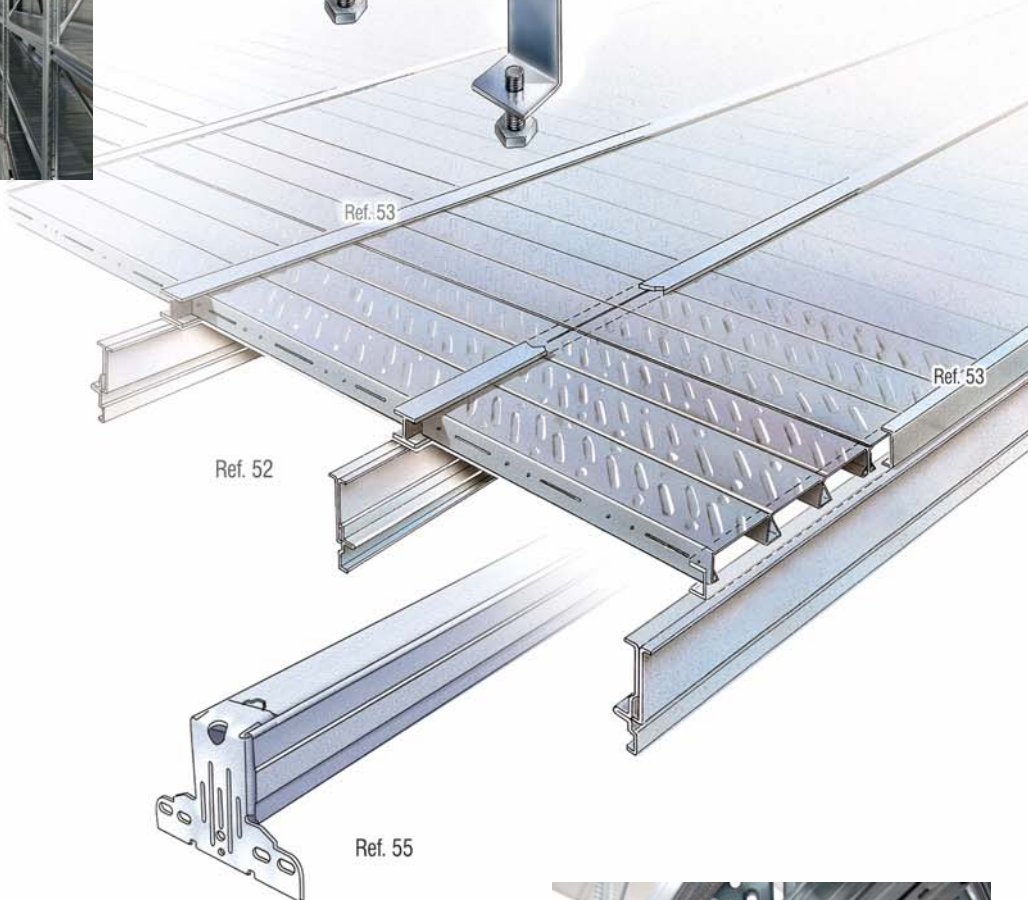

Steel Plank Fixing Accessories

Description	Article
STEEL PLANK CLAMP + 8MA BOLT	69829.95+00056.20
BRACKET UP TO 20 mm + M10X20 BOLT	69861.98
BRACKET UP TO 40 mm + M10X20 BOLT	69862.98
BRACKET UP TO 60 mm + M10X20 BOLT	69863.98

Mezzanine Walkway Beam

Walkway beams provide an alternative solution to the use of "T"-section support bars, enabling the steel planks to be laid in length direction along the walkways (Ref. 55). The mezzanine walkway beam comes as a 70x70/6 profile with perforations along one face of the profile. The perforations must face down in order to connect the steel plank fixing bracket (art. n° 69864.98). The walkway beam offers great continuity at steel plank joints. The walkway beam connection bracket (art. n° AI210082.95), sits perfectly into the "T-Section" support bracket (art. n° SLACC130.95) and can be easily assembled on site. Two self-perforating screws will serve as safety fastening, the installation of such screws is mandatory. The walkway beam is ordered in the nominal corridor dimension.

Walkway Beam Assembly

Ref.	Article	Description	Qty
1	AI210013.95	PROFILE 70X70/6	x1
2	AI210082.95	WALKWAY BEAM BRACKET	x2
3	69864.98	STEEL PLANK FIXING BRACKET	x2
4	00058.20	5,5X19 HEXSDAP SCREW	x2
5	SLACC130.95	T-SECTION SUPPORT BAR BRACKET	x2

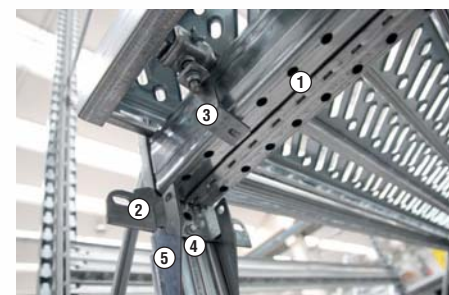

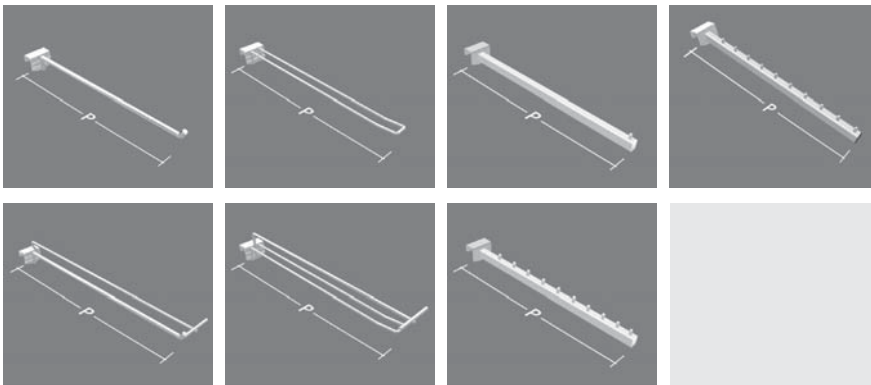

Trendy Shopfitting and Display Solutions

May be easily achieved with standard modular Unirack shelving components. Thanks to its attractive high-tech design, the system is trendy and pleasing to the eye. It can provide unique and highly cost effective solutions for shop fitting applications. Some application examples are featured on this page.

Shopfitting Accessories

A wide range of hooks, wire rods and bars with pegs are available for supply. These items fit onto the oval beams in 10/10 and 18/10 mm gauge (art. n° 36051.95-36810.95 – see pages 43 and 51 of this brochure).

Reinforcement Bar

This solution couples two connection brackets with a standard 40x20 mm oval section to create a reinforced connection between two uprights of a shelving bay, substantially increasing the stiffness of the shelving row (Ref. 65). This is an ideal solution for a wide range of applications where firmness is an added value, such as hanging garment shelving and retail furnishing solutions, generally characterised by low frame heights, few beam levels and short shelving row configurations. The design of the connection bracket creates a four pronged connection to the uprights while maintaining full access to the bay. This unique solution not only guarantees flexibility in application but, more importantly, it ensures extraordinary nodal performance. Reinforcement bars, like any other standard beam component, require the mandatory application of safety pins.

For more information, please refer to METALSISTEM Informa n° 706 and to page n° 50 of this brochure.



Mobibasic - Mobile Shelving

Thanks to its attractive high-tech design, Unirack is also a highly suitable and cost effective system to achieve mobile shelving applications. For the design and ordering of mobile shelving installations, please refer to the Mobibasic Technical Manual <Doc: MT16>.

Modular Sliding Doors

Sliding doors are ideal for areas with limited corridor width and can be used to create closed spaces or cupboards. Sliding doors are supplied preassembled and are available in the standard METALSISTEM colour range. A lock is supplied as a standard accessory with every door. Sliding doors are available for 900/1200/1500 mm bay lengths, in two different heights: 2000 and 2500 mm. The sliding rails are made to match the height of the shelving beams on top and at the bottom of the shelving bay. In case of Mobibasic mobile shelving installations, the rails are fixed directly to the Mobibasic chassis and to the shelving beam on top of the bay, to ensure a dust proof connection. For more information and ordering, please refer to page 41.

Modular Steel Cabinets

Made from our shelving series and clad with Euroscacco steel panels, these cabinets are equipped with lockable sliding doors and are highly performing in terms of load bearing capacity. Available in zinc coated or powder coated version (Ref. 60).

The standard configuration has been conceived with four modular, adjustable steel shelves made from Super 1 beams and H12 shelf panels; other configurations can be easily achieved thanks to the modular design.

Customers may use shelving components from their stock to build the framework and just order the cladding set to build the cabinet.

Compared to similar products available on the market, METALSISTEM steel cabinets distinguish themselves by higher load capacities, utmost cost efficiency and solidity. Available as well in a width of 1500 mm: a feature that is not common for this product category. For ordering, see page 41.

Mobile Ladders

Mobile ladders are available in 2000/2500/3000 mm height (in 5, 7 or 9 steps configuration) and can be supplied with guide rail and curves to adapt them to any environment (Ref. 56).

For ordering please refer to page 50.



Ref. 60



Ref. 60



Ref. 60



Ref. 56



Carton Flow

Carton flow beds consist of one or more inclined runways equipped with specially designed roller tracks. Merchandise is loaded in the rear of each runway and moves toward the picking station. As an item is removed from the front, the item directly behind it slides forward in place of the previous and rolls to the front, thus allowing merchandise to remain better organized and easier to find/pick.

METALSISTEM's carton flow is an economic, modular and functional solution based on standard components alone, allowing flow track beds to be created up to depths of 4 metres. The flow track profiles are made from certified, galvanised, high tensile steel and are manufactured in lengths ranging from 359 to 4022 mm at a cut pitch of 33 mm. Yellow rollers made from polypropylene are inserted into the tracks at varying pitches of either 33, 49.5, 66, 82.5 or 99 mm, according to the application requirements. The track profiles are inserted into scenestrips that are fastened with clamps/screws (art. 69829.95/00056.20) at centre distances of approx. 1000 mm.

The support for the roller shelves is provided by frames placed at fixed intervals set by oval tubes, (the same standard components used for walkway parapet elements) thus ensuring that the beams will be aligned at a constant inclination of approximately 8% from the rear to the front side of the system. However, the most suitable degree of inclination depends on the type of packaging and weight of the load unit and the overall length of the roller track. A "T"-section support bar placed at the picking side of the run provides both support for the flow tracks and an end stop for the cartons. For more information please refer to page 55 of this brochure.

Removable Divider

The roller beds can be equipped with removable dividers that make use of the 32/4 zinc-coated profile. They are installed by pressure, therefore the width of lanes can be changed easily.

The divider can cover the entire length of the roller bed but can also be used as partial start or end roller bed division.



SERIES: USP for solid shelves

PATENTED ADJUSTABLE SHELVING SYSTEM

FRAMES- SERIES USP COMPLETE WITH UPRIGHTS, HORIZONTAL AND DIAGONAL BRACING LOAD BEARING CAPACITY 2300 daN EACH

Regarding technical data, standard specifications and assembly diagram, please refer to pages 4/5 of the Unirack brochure.

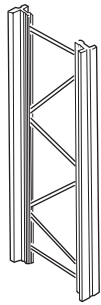

Ref. 1b

article	height mm	depth mm
USP03X20.95	2000	320
USP03X25.95	2500	320
USP03X30.95	3000	320
USP03X35.95	3500	320
USP04X20.95	2000	400
USP04X25.95	2500	400
USP04X30.95	3000	400
USP04X35.95	3500	400
USP05X20.95	2000	500
USP05X25.95	2500	500
USP05X30.95	3000	500
USP05X35.95	3500	500
USP06X20.95	2000	600
USP06X25.95	2500	600
USP06X30.95	3000	600
USP06X35.95	3500	600

The frames of the USP series can be used with solid shelves H30 only.

SOLID SHELVES H 30 USP SERIES

Ref. 14

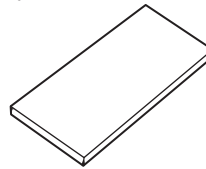

SHELF CLIP USP SERIES



REINFORCER FOR H 30 SOLID SHELVES, ZINC COATED USP SERIES

article	length mm	depth mm	load capacity daN unif. distr. load
SLPIA083.95	800	320	120
SLPIA084.95	800	400	120
SLPIA085.95	800	500	120
SLPIA086.95	800	600	120
SLPIA103.95	1000	320	100
SLPIA104.95	1000	400	100
SLPIA105.95	1000	500	100
SLPIA106.95	1000	600	100
SLPIA123.95	1200	320	80
SLPIA124.95	1200	400	80
SLPIA125.95	1200	500	80
SLPIA126.95	1200	600	80
SLACC023.95			
SLRIN080.95	800		
SLRIN100.95	1000		
SLRIN120.95	1200		

The solid shelves can be used with USP frame series only.

UPRIGHT USP FOR H 30 SOLID SHELVES



Ref. 1b

article	height mm
USP2000.95	2000
USP2500.95	2500
USP3000.95	3000
USP3500.95	3500

VERT. SLID. DIVIDERS FOR SOLID SHELVES H 30 USP SERIES

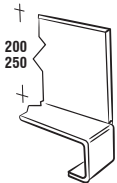

article	height mm	depth mm
SLDS3020.95	200	320
SLDS3025.95	250	320
SLDS4020.95	200	400
SLDS4025.95	250	400
SLDS5020.95	200	500
SLDS5025.95	250	500
SLDS6020.95	200	600
SLDS6025.95	250	600



ITEM:	Single Sided Plastic Bin Trolley	Double Sided Plastic Bin Trolley
article	00005598.98	00005179.98
dimension <LxDxH> mm:	720 x 390 x 1210	1120 x 500 x 1240
load levels:	6 single sided levels	7 double sided levels

Description: trolley on four rubber rimmed swivelling castors, two with brakes. Designed to accommodate BULL plastic bin series on 6 or 7 levels in height, respectively. Suited for BULL-1/K1 to BULL-3/K3 plastic bin series. The trolleys are supplied preassembled in kit from; the kit does not contain the modular plastic bins, these need to be ordered separately.

ACCESSORIES/COMPONENTS

UNIRACK SERIES

PATENTED ADJUSTABLE SHELVING SYSTEM

LOCKABLE DOOR, GREY RAL 7001



article	length x height mm
68201.98	900x2000H
68204.98	1200x2000H
68207.98	1500x2000H
68210.98	900x2500H
68213.98	1200x2500H
68216.98	1500x2500H

LOCKABLE SLIDING DOOR

- standard surface finish: powder coated blue, RAL 5010
- other colours are available upon request
- see also METALSISTEM Informa n° 583



bay length x height mm	zinc coated version article	powder coated version article
900x2000H	SLACC400.98	SLACC400.--
1200x2000H	SLACC402.98	SLACC402.--
1500x2000H	SLACC404.98	SLACC404.--
900x2500H	SLACC410.98	SLACC410.--
1200x2500H	SLACC412.98	SLACC412.--
1500x2500H	SLACC414.98	SLACC414.--



Ref. 62

LxDxH overall dimension <mm> 1030/1330/1630x610x2000

STEEL CABINET WITH 4 MODULAR SHELF PANELS made from SUPER-1-beams and H-12-mm panels and lockable sliding doors. Cabinet available in zinc coated version or with powder coated cladding. Standard colours: red RAL 3000, blue RAL 5010, yellow RAL 1004.

Ref. 62

CLADDING SET made from side/back/top (*) cladding panels. (*) top cladding panel standard zinc coated. Cladding Set includes fastening accessories

Ref. 62

bay length x depth x height nominal dimension mm	zinc coated version article	powder coated version article	zinc coated version article	powder coated version article
900x500x2000	US210001.95	US210001.--	US210004.95	US210004.--
1200x500x2000	US210002.95	US210002.--	US210005.95	US210005.--
1500x500x2000	US210003.95	US210003.--	US210006.95	US210006.--

**FRAMES- SERIES USA
COMPLETE WITH UPRIGHTS,
HORIZONTAL AND DIAGONAL
BRACING**
**LOAD BEARING CAPACITY
2600 daN EACH.**

Regarding technical data, standard specifications and assembly diagram, please refer to pages 4/5 of the Unirack brochure.

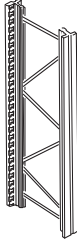

Ref. 2a

article	height mm	depth mm	article	height mm	depth mm
USA03x20.95	2000	320	USA06x20.95	2000	600
USA03x25.95	2500	320	USA06x25.95	2500	600
USA03x30.95	3000	320	USA06x30.95	3000	600
USA03x35.95	3500	320	USA06x35.95	3500	600
USA04x20.95	2000	400	USA07x20.95	2000	700
USA04x25.95	2500	400	USA07x25.95	2500	700
USA04x30.95	3000	400	USA07x30.95	3000	700
USA04x35.95	3500	400	USA07x35.95	3500	700
USA05x20.95	2000	500	USA08x20.95	2000	800
USA05x25.95	2500	500	USA08x25.95	2500	800
USA05x30.95	3000	500	USA08x30.95	3000	800
USA05x35.95	3500	500	USA08x35.95	3500	800

**UPRIGHT
USA**

Ref. 2



article	height mm
USA2000.95	2000
USA2500.95	2500
USA3000.95	3000
USA3500.95	3500

BEAM S1G

Ref. 6

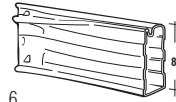

article	length mm	Load <daN> per pair uniformly distrib. load
32604.95	1500	350
32607.95	1800	310

The load bearing capacity of the beams is to be understood as referring to uniformly distributed loads, per pair of beams. The load bearing indication is valid and applicable for a use of the beams with modular shelves and/or modular containers only.

BEAM S1

Ref. 5



article	length mm	Load <daN> per pair uniformly distrib. load
30000.95	600	280
30001.95	900	280
30003.95	1050	235
30004.95	1200	205
30005.95	1350	180
30007.95	1500	145
30008.95	1650	120

BEAM S-O

Ref. 5

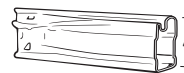

article	length mm	Load <daN> per pair uniformly distrib. load
30000L.95	600	200
30001L.95	900	200
30003L.95	1050	170
30004L.95	1200	150

**COMPLETE SHELVES
WITH BEAMS S-O
AND PANELS H12**

Regarding technical data and standard specifications, please refer to pages 4/5.

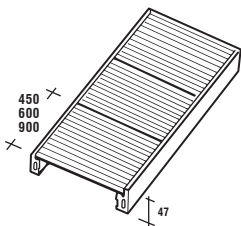

Ref. 11

article	length mm	depth mm	Load capacity <daN> uniformly distrib. load
80001.95	900	320	200
80004.95	900	400	200
80007.95	900	500	185
80010.95	900	600	150
80013.95	900	700	130
80014.95	1050	320	170
80015.95	1050	400	170
80016.95	1050	500	170
80017.95	1050	600	170
80018.95	1050	700	155
80019.95	1200	320	150
80022.95	1200	400	150
80025.95	1200	500	150
80028.95	1200	600	150
80031.95	1200	700	150

**COMPLETE SHELVES
WITH BEAMS S-O
AND PANELS H25/A**

Regarding technical data and standard specifications, please refer to pages 4/5.

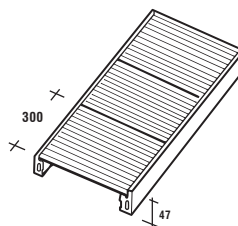

Ref. 13

article	length mm	depth mm	Load capacity <daN> uniformly distrib. load
80004A.95	900	400	200
80007A.95	900	500	200
80010A.95	900	600	200
80013A.95	900	700	200
80016A.95			
80022A.95	1200	400	150
80025A.95	1200	500	150
80028A.95	1200	600	150
80031A.95	1200	700	150
80034A.95	1200	800	150

**COMPLETE SHELVES
WITH BEAMS S1
AND PANELS H12**

Regarding technical data and standard specifications, please refer to pages 4/5.

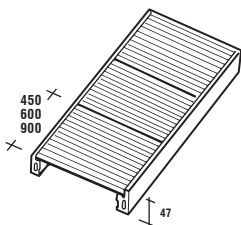

Ref. 11

article	length mm	depth mm	Load capacity <daN> uniformly distrib. load
80501.95	900	320	280
80504.95	900	400	235
80507.95	900	500	185
80510.95	900	600	150
80513.95	900	700	130
80519.95	1200	320	205
80522.95	1200	400	205
80525.95	1200	500	205
80528.95	1200	600	205
80531.95	1200	700	180
80537.95	1500	320	145
80540.95	1500	400	145
80543.95	1500	500	145
80546.95	1500	600	145
80549.95	1500	700	145

**COMPLETE SHELVES
WITH BEAMS S1
AND PANELS H25/A**

Regarding technical data and standard specifications, please refer to pages 4/5.

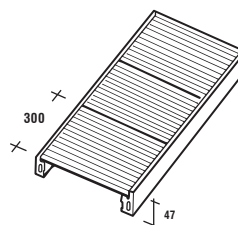

Ref. 13

article	length mm	depth mm	Load capacity <daN> uniformly distrib. load
80504A.95	900	400	280
80507A.95	900	500	280
80510A.95	900	600	280
80513A.95	900	700	280
80516A.95	900	800	230
80522A.95	1200	400	205
80525A.95	1200	500	205
80528A.95	1200	600	205
80531A.95	1200	700	205
80534A.95	1200	800	180
80540A.95	1500	400	145
80543A.95	1500	500	145
80546A.95	1500	600	145
80549A.95	1500	700	145
80552A.95	1500	800	130

SERIES: USB

PATENTED ADJUSTABLE SHELVING SYSTEM

FRAMES- SERIES USB COMPLETE WITH UPRIGHTS, HORIZONTAL AND DIAGONAL BRACING

**LOAD BEARING CAPACITY
3000 daN EACH.**

Regarding technical data, standard specifications and assembly diagram, please refer to pages 4/5 of the Unirack brochure.

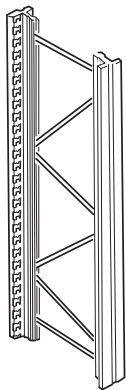

Ref. 2a

article	height mm	depth mm
USB03X20.95	2000	320
USB03X25.95	2500	320
USB03X30.95	3000	320
USB03X35.95	3500	320
USB03X40.95	4000	320
USB03X45.95	4500	320

article	height mm	depth mm
USB04X20.95	2000	400
USB04X25.95	2500	400
USB04X30.95	3000	400
USB04X35.95	3500	400
USB04X40.95	4000	400
USB04X45.95	4500	400

article	height mm	depth mm
USB05X20.95	2000	500
USB05X25.95	2500	500
USB05X30.95	3000	500
USB05X35.95	3500	500
USB05X40.95	4000	500
USB05X45.95	4500	500

article	height mm	depth mm
USB06X20.95	2000	600
USB06X25.95	2500	600
USB06X30.95	3000	600
USB06X35.95	3500	600
USB06X40.95	4000	600
USB06X45.95	4500	600

article	height mm	depth mm
USB07X20.95	2000	700
USB07X25.95	2500	700
USB07X30.95	3000	700
USB07X35.95	3500	700
USB07X40.95	4000	700
USB07X45.95	4500	700

article	height mm	depth mm
USB08X20.95	2000	800
USB08X25.95	2500	800
USB08X30.95	3000	800
USB08X35.95	3500	800
USB08X40.95	4000	800
USB08X45.95	4500	800

UPRIGHT USB

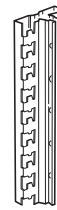

Ref. 2

article	height mm
USB2000.95	2000
USB2500.95	2500
USB3000.95	3000
USB3500.95	3500
USB4000.95	4000
USB4500.95	4500

BEAM S2



Ref. 5

article	length mm	Load <daN> per pair uniformly distrib. load
31501.95	900	390
31503.95	1050	335
31504.95	1200	275
31505.95	1350	220
31507.95	1500	175
31508.95	1650	145

BEAM S2G

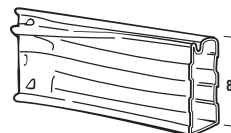

Ref. 6

article	length mm	Load <daN> per pair uniformly distrib. load
34004.95	1500	520
34007.95	1800	430

The load bearing capacity of the beams is to be understood as referring to uniformly distributed loads, per pair of beams. The load bearing indication is valid and applicable for a use of the beams with modular shelves and/or modular containers only.

COMPLETE SHELVES WITH BEAMS S2 AND PANELS H12

Regarding technical data and standard specifications, please refer to pages 4/5.

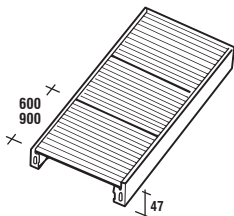

Ref. 11

article	length mm	depth mm	Load capacity <daN> uniformly distrib. load
81001.95	900	320	305
81004.95	900	400	235
81007.95	900	500	185
81010.95	900	600	150
81013.95	900	700	130

81019.95	1200	320	275
81022.95	1200	400	275
81025.95	1200	500	260
81028.95	1200	600	210
81031.95	1200	700	180

81037.95	1500	320	175
81040.95	1500	400	175
81043.95	1500	500	175
81046.95	1500	600	175
81049.95	1500	700	175

COMPLETE SHELVES WITH BEAMS S2 AND PANELS H25/A

Regarding technical data and standard specifications, please refer to pages 4/5.

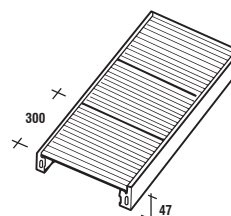

Ref. 13

article	length mm	depth mm	Load capacity <daN> uniformly distrib. load
81504A.95	900	400	390
81507A.95	900	500	390
81510A.95	900	600	345
81513A.95	900	700	285
81516A.95	900	800	230

81522A.95	1200	400	275
81525A.95	1200	500	275
81528A.95	1200	600	275
81531A.95	1200	700	275
81534A.95	1200	800	250

81540A.95	1500	400	175
81543A.95	1500	500	175
81546A.95	1500	600	175
81549A.95	1500	700	175
81552A.95	1500	800	160

SHOPFITTING ACCESSORIES – CHROME-PLATED WIRE HOOKS FOR OVAL SHAPED BEAMS (page 51)

article	depth mm	article	depth mm	article	depth mm	article	depth mm
	031.006.21 350		031.025.21 350		207.004.21 350		207.024.21 350
	031.005.21 400		207.006.21 450		207.026.21 450		
	031.028.21 350		031.086.21 200		207.014.21 350		
	031.031.21 400		031.080.21 400		207.016.21 450		
	031.030.21 500						

**FRAMES- SERIES USM
COMPLETE WITH UPRIGHTS,
HORIZONTAL AND DIAGONAL
BRACING
LOAD BEARING CAPACITY
4200 daN EACH.**

Regarding technical data, standard specifications and assembly diagram, please refer to pages 4/5 of the Unirack brochure.

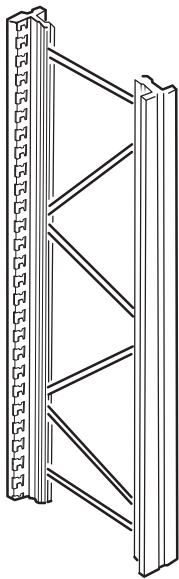

Ref. 2a

article	height mm	depth mm
USM03X20.95	2000	320
USM03X25.95	2500	320
USM03X30.95	3000	320
USM03X35.95	3500	320
USM03X40.95	4000	320
USM03X45.95	4500	320
USM03X50.95	5000	320
USM03X55.95	5500	320
USM03X60.95	6000	320
USM03X65.95	6500	320
USM03X70.95	7000	320
USM04X20.95	2000	400
USM04X25.95	2500	400
USM04X30.95	3000	400
USM04X35.95	3500	400
USM04X40.95	4000	400
USM04X45.95	4500	400
USM04X50.95	5000	400
USM04X55.95	5500	400
USM04X60.95	6000	400
USM04X65.95	6500	400
USM04X70.95	7000	400
USM05X20.95	2000	500
USM05X25.95	2500	500
USM05X30.95	3000	500
USM05X35.95	3500	500
USM05X40.95	4000	500
USM05X45.95	4500	500
USM05X50.95	5000	500
USM05X55.95	5500	500
USM05X60.95	6000	500
USM05X65.95	6500	500
USM05X70.95	7000	500
USM06X20.95	2000	600
USM06X25.95	2500	600
USM06X30.95	3000	600
USM06X35.95	3500	600
USM06X40.95	4000	600
USM06X45.95	4500	600
USM06X50.95	5000	600
USM06X55.95	5500	600
USM06X60.95	6000	600
USM06X65.95	6500	600
USM06X70.95	7000	600
USM07X20.95	2000	700
USM07X25.95	2500	700
USM07X30.95	3000	700
USM07X35.95	3500	700
USM07X40.95	4000	700
USM07X45.95	4500	700
USM07X50.95	5000	700
USM07X55.95	5500	700
USM07X60.95	6000	700
USM07X65.95	6500	700
USM07X70.95	7000	700
USM08X20.95	2000	800
USM08X25.95	2500	800
USM08X30.95	3000	800
USM08X35.95	3500	800
USM08X40.95	4000	800
USM08X45.95	4500	800
USM08X50.95	5000	800
USM08X55.95	5500	800
USM08X60.95	6000	800
USM08X65.95	6500	800
USM08X70.95	7000	800

**FRAMES- SERIES USR
COMPLETE WITH UPRIGHTS,
HORIZONTAL AND DIAGONAL
BRACING
LOAD BEARING CAPACITY
4800 daN EACH.**

Regarding technical data, standard specifications and assembly diagram, please refer to pages 4/5 of the Unirack brochure.

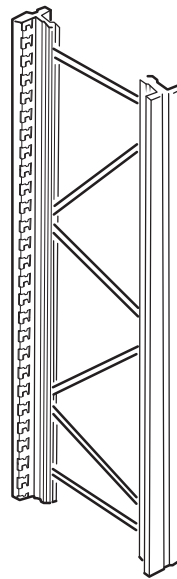

Ref. 1a

article	height mm	depth mm
USR04X20.95	2000	400
USR04X25.95	2500	400
USR04X30.95	3000	400
USR04X35.95	3500	400
USR04X40.95	4000	400
USR04X45.95	4500	400
USR04X50.95	5000	400
USR04X55.95	5500	400
USR04X60.95	6000	400
USR04X65.95	6500	400
USR04X70.95	7000	400
USR04X75.95	7500	400
USR04X80.95	8000	400
USR05X20.95	2000	500
USR05X25.95	2500	500
USR05X30.95	3000	500
USR05X35.95	3500	500
USR05X40.95	4000	500
USR05X45.95	4500	500
USR05X50.95	5000	500
USR05X55.95	5500	500
USR05X60.95	6000	500
USR05X65.95	6500	500
USR05X70.95	7000	500
USR05X75.95	7500	500
USR05X80.95	8000	500
USR06X20.95	2000	600
USR06X25.95	2500	600
USR06X30.95	3000	600
USR06X35.95	3500	600
USR06X40.95	4000	600
USR06X45.95	4500	600
USR06X50.95	5000	600
USR06X55.95	5500	600
USR06X60.95	6000	600
USR06X65.95	6500	600
USR06X70.95	7000	600
USR06X75.95	7500	600
USR06X80.95	8000	600
USR07X20.95	2000	700
USR07X25.95	2500	700
USR07X30.95	3000	700
USR07X35.95	3500	700
USR07X40.95	4000	700
USR07X45.95	4500	700
USR07X50.95	5000	700
USR07X55.95	5500	700
USR07X60.95	6000	700
USR07X65.95	6500	700
USR07X70.95	7000	700
USR07X75.95	7500	700
USR07X80.95	8000	700
USR08X20.95	2000	800
USR08X25.95	2500	800
USR08X30.95	3000	800
USR08X35.95	3500	800
USR08X40.95	4000	800
USR08X45.95	4500	800
USR08X50.95	5000	800
USR08X55.95	5500	800
USR08X60.95	6000	800
USR08X65.95	6500	800
USR08X70.95	7000	800
USR08X75.95	7500	800
USR08X80.95	8000	800

Note: Reinforced Unirack frames are also available, for installations within seismic areas, for Miniload applications, for the construction of two-tier constructions with frame depths > 800mm, for applications with a need for frames of increased rigidity. For the calculation and design of such installations, customers should contact METALSISTEM's Technical Department. Reinforced Unirack frames are built with bracing items made from rectangular tubes with flanged ends, bolted onto the Unirack uprights.

Unirack USM-R series are available in frame depths of 400-1000 mm - **Unirack USR-R series** are available in frame depths of 400-1200 mm; Modular Shelf Panels H25/B and H25/C for frame depths 900-1200 mm are also available and must be used for the reinforced Unirack frame series "USM-R and USR-R" only and exclusively. For more information, see als METALSISTEM Informa n° 574 and the technical table <TRCL01 Rev.1 dated 04.03.10>.

UPRIGHT USM

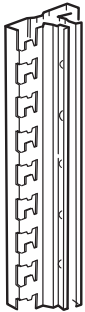

Ref. 2

article	height mm
USM2000.95	2000
USM2500.95	2500
USM3000.95	3000
USM3500.95	3500
USM4000.95	4000
USM4500.95	4500
USM5000.95	5000
USM5500.95	5500
USM6000.95	6000
USM6500.95	6500
USM7000.95	7000

UPRIGHT USR

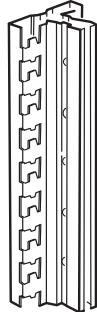

Ref. 1

article	height mm
USR2000.95	2000
USR2500.95	2500
USR3000.95	3000
USR3500.95	3500
USR4000.95	4000
USR4500.95	4500
USR5000.95	5000
USR5500.95	5500
USR6000.95	6000
USR6500.95	6500
USR7000.95	7000
USR7500.95	7500
USR8000.95	8000

BEAM S3



Ref. 5

article	length mm	Load <daN> per pair uniformly distrib. load
32501.95	900	450
32503.95	1050	385
32504.95	1200	320
32505.95	1350	255
32507.95	1500	205
32508.95	1650	170
32510.95	1800	140

The load bearing capacity of the beams is to be understood as referring to uniformly distributed loads, per pair of beams. The load bearing indication is valid and applicable for a use of the beams with modular shelves and/or modular containers only.

BEAM S3 G

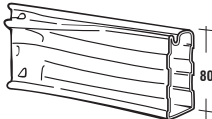

Ref. 6

article	length mm	Load <daN> per pair uniformly distrib. load
35004.95	1500	640
35007.95	1800	530

The load bearing capacity of the beams is to be understood as referring to uniformly distributed loads, per pair of beams. The load bearing indication is valid and applicable for a use of the beams with modular shelves and/or modular containers only.

COMPLETE SHELVES WITH BEAMS S3 AND PANELS H12

Regarding technical data and standard specifications, please refer to pages 4/5.

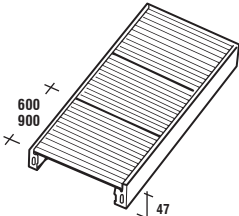

Ref. 11

article	length mm	depth mm	Load capacity <daN> uniformly distrib. load	article	length mm	depth mm	Load capacity <daN> uniformly distrib. load
82001.95	900	320	305	82037.95	1500	320	205
82004.95	900	400	235	82040.95	1500	400	205
82007.95	900	500	185	82043.95	1500	500	205
82010.95	900	600	150	82046.95	1500	600	205
82013.95	900	700	130	82049.95	1500	700	205
82019.95	1200	320	320	82055.95	1800	320	140
82022.95	1200	400	320	82058.95	1800	400	140
82025.95	1200	500	260	82061.95	1800	500	140
82028.95	1200	600	210	82064.95	1800	600	140
82031.95	1200	700	180	82067.95	1800	700	140

COMPLETE SHELVES WITH BEAMS S3 AND PANELS H25/A

Regarding technical data and standard specifications, please refer to pages 4/5.

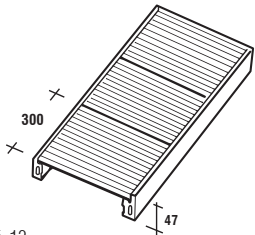

Ref. 13

article	length mm	depth mm	Load capacity <daN> uniformly distrib. load	article	length mm	depth mm	Load capacity <daN> uniformly distrib. load
82504A.95	900	400	450	82540A.95	1500	400	205
82507A.95	900	500	420	82543A.95	1500	500	205
82510A.95	900	600	345	82546A.95	1500	600	205
82513A.95	900	700	285	82549A.95	1500	700	205
82516A.95	900	800	230	82552A.95	1500	800	180
82522A.95	1200	400	320	82564A.95	1800	400	140
82525A.95	1200	500	320	82567A.95	1800	500	140
82528A.95	1200	600	320	82570A.95	1800	600	140
82531A.95	1200	700	320	82573A.95	1800	700	140
82534A.95	1200	800	290				

COMPLETE SHELVES WITH BEAMS S1G AND PANELS H12 mm

Regarding technical data and standard specifications, please refer to pages 4/5.

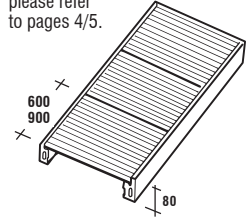

article	length mm	depth mm	Load capacity <daN> uniformly distrib. load
83116.95	1500	320	350
83119.95	1500	400	350
83122.95	1500	500	315
83125.95	1500	600	260
83128.95	1500	700	220
83131.95	1800	320	310
83134.95	1800	400	310
83137.95	1800	500	310
83140.95	1800	600	305
83143.95	1800	700	260

COMPLETE SHELVES WITH BEAMS S1G AND PANELS H25/A

Regarding technical data and standard specifications, please refer to pages 4/5.

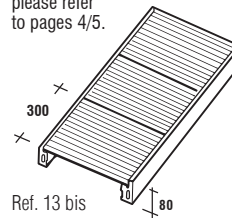

article	length mm	depth mm	Load capacity <daN> uniformly distrib. load
83340A.95	1500	400	350
83343A.95	1500	500	350
83346A.95	1500	600	350
83349A.95	1500	700	350
83352A.95	1500	800	350
83364A.95	1800	400	310
83367A.95	1800	500	310
83370A.95	1800	600	310
83373A.95	1800	700	310

COMPLETE SHELVES WITH BEAMS S2G AND PANELS H25/A

Regarding technical data and standard specifications, please refer to pages 4/5.

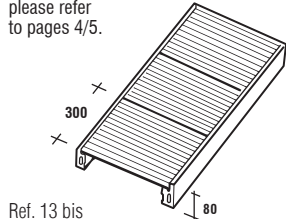

article	length mm	depth mm	Load capacity <daN> uniformly distrib. load
83540A.95	1500	400	520
83543A.95	1500	500	520
83546A.95	1500	600	520
83549A.95	1500	700	520
83552A.95	1500	800	425
83564A.95	1800	400	430
83567A.95	1800	500	430
83570A.95	1800	600	430
83573A.95	1800	700	430

COMPLETE SHELVES WITH BEAMS S3G AND PANELS H25/A

Regarding technical data and standard specifications, please refer to pages 4/5.

Ref. 13 bis

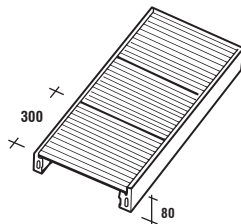

COMPLETE SHELVES WITH BEAMS S3G AND PANELS H25/B

Regarding technical data and standard specifications, please refer to pages 4/5.

Ref. 13 bis

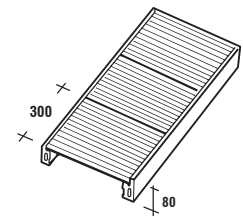

article	length mm	depth mm	Load capacity <daN> uniformly distrib. load
84540A.95	1500	400	640
84543A.95	1500	500	640
84546A.95	1500	600	640
84549A.95	1500	700	475
84552A.95	1500	800	425
84564A.95	1800	400	530
84567A.95	1800	500	530
84570A.95	1800	600	530
84573A.95	1800	700	530

article	length mm	depth mm	Load capacity <daN> uniformly distrib. load
84540B.95	1500	400	640
84543B.95	1500	500	640
84546B.95	1500	600	640
84549B.95	1500	700	550
84552B.95	1500	800	475
84564B.95	1800	400	530
84567B.95	1800	500	530
84570B.95	1800	600	530
84573B.95	1800	700	530

PERFORATED SHELF PANEL 300 mm wide - H25 - with flanged ends hole diameter 6.5 mm perforation 50% of the shelf surface

Regarding technical data and standard specifications, please refer to pages 4/5 of this brochure and to METALSISTEM Informa n° 577.

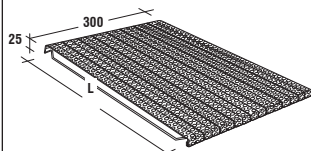

article H25/C	load capacity <daN> uniformly distrib. load	depth mm	article H25/D	load capacity <daN> uniformly distrib. load
52521.95	150	400	52541.95	180
52524.95	150	500	52544.95	180
52527.95	120	600	52547.95	150
52530.95	95	700	52550.95	120
52533.95	70	800	52553.95	85

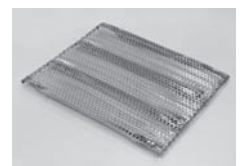

The load bearing capacities indicated in this table refer to uniformly distributed loads <daN> per shelf panel.

The load bearing capacity of a complete shelf will be given by the smallest value between the load bearing capacity per pair of beams against the sum of load bearing capacities of the number of shelf panels in the bay. If the load capacity per pair of beams is lower compared to the sum of shelf panels, then the lower data will apply.

We recommend care when using containers with steel runners or steel foot plates or other items introducing point loads: due to the perforated shelf surface, the shelf panels are not suited to accept point loads. See also METALSISTEM Informa n° 577.

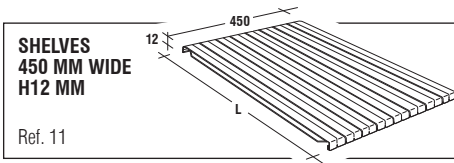

**SHELVES
450 MM WIDE
H12 MM**
Ref. 11

article	depth mm
51701.95	320
51704.95	400
51707.95	500
51710.95	600
51713.95	700

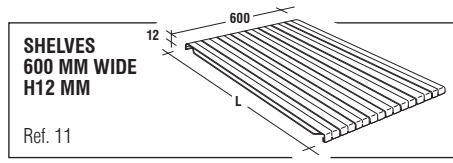

**SHELVES
600 MM WIDE
H12 MM**
Ref. 11

article	depth mm
51101.95	320
51104.95	400
51107.95	500
51110.95	600
51113.95	700

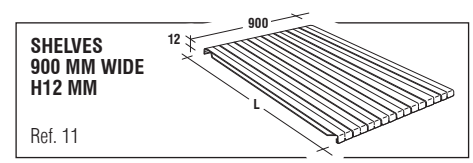

**SHELVES
900 MM WIDE
H12 MM**
Ref. 11

article	depth mm
51601.95	320
51604.95	400
51607.95	500
51610.95	600
51613.95	700

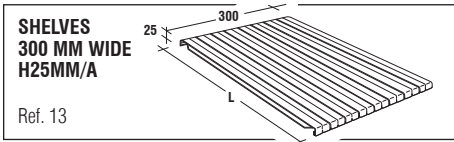

**SHELVES
300 MM WIDE
H25MM/A**
Ref. 13

article	depth mm
52301.95	400
52304.95	500
52307.95	600
52310.95	700
52313.95	800

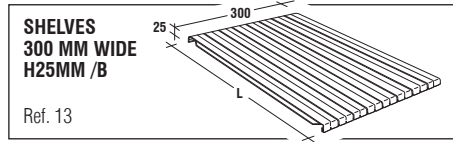

**SHELVES
300 MM WIDE
H25MM/B**
Ref. 13

article	depth mm
52401.95	400
52404.95	500
52407.95	600
52410.95	700
52413.95	800

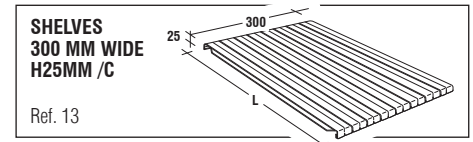

**SHELVES
300 MM WIDE
H25MM/C**
Ref. 13

article	depth mm
52501.95	400
52504.95	500
52507.95	600
52510.95	700
52513.95	800

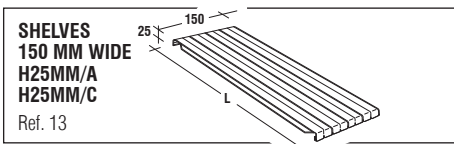

**SHELVES
150 MM WIDE
H25MM/A
H25MM/C**
Ref. 13

H25/A article	depth mm	H25/C article
52271.95	400	52471.95
52274.95	500	52474.95
52277.95	600	52477.95
52280.95	700	52480.95
52283.95	800	52483.95

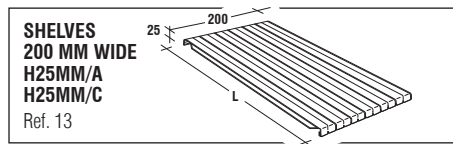

**SHELVES
200 MM WIDE
H25MM/A
H25MM/C**
Ref. 13

H25/A article	depth mm	H25/C article
52290.95	400	52490.95
52292.95	500	52492.95
52294.95	600	52494.95
52296.95	700	52496.95
52298.95	800	52498.95



**FASTENING CLIP
FOR SHELF PANELS**
Ref. 66

article
AL210005.95



**BACK CLADDING PANELS H12
FOR BACK-TO-BACK BAYS**
pag. 25

article	height x width mm	article	height x width mm	article	height x width mm
63510.95	1485x450	63001.95	1485x600	63501.95	1485x900
63513.95	1940x450	63004.95	1940x600	63504.95	1940x900
63516.95	2480x450	63007.95	2480x600	63507.95	2480x900
63518.95	2980x450	63009.95	2980x600	63509.95	2980x900

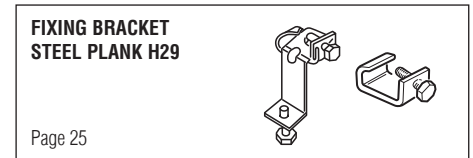

**FIXING BRACKET
STEEL PLANK H29**
Page 25

article
69829.95
00056.20
69862.98

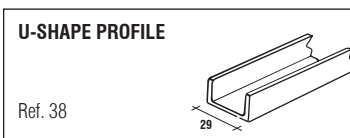

U-SHAPE PROFILE
Ref. 38

article	length mm
for H29	69801.95 4000
for H58	69807.95 4000
for H68	69808.95 4000

H-SHAPE PROFILE
Ref. 38

article	length mm
for H29	69804.95 4000
for H58	69810.95 4000

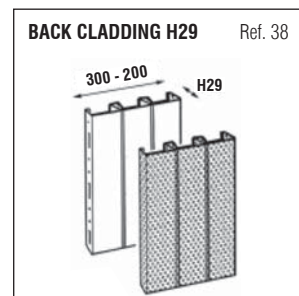

BACK CLADDING H29 Ref. 38

article	depth mm	version
63101.95	300	smooth
63104.95	300	perforated
63107.95	300	ribbed
63110.95	300	punchholed
63111.95	200	smooth
63114.95	200	perforated
63117.95	200	ribbed
63120.95	200	punchholed

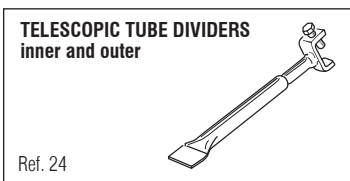

**TELESCOPIC TUBE DIVIDERS
inner and outer**
Ref. 24

article	height mm
67290.95	280 inner
67293.95	280 outer
67296.95	560 inner
67299.95	560 outer

**DIVIDER FOR
EXHAUST PIPES**
Ref. 25

article	height mm
67301.98	horizontal
67302.98	vertical

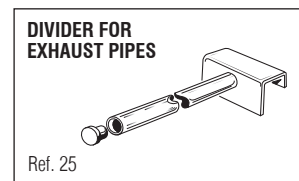

**DIVIDER FOR
EXHAUST PIPES**
Ref. 25









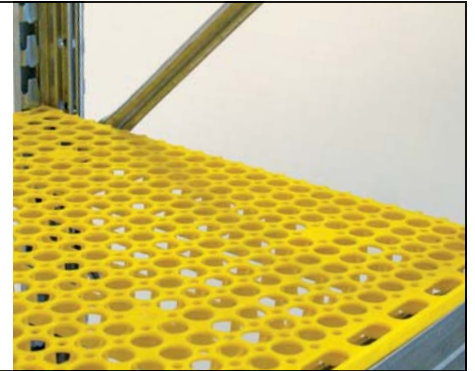



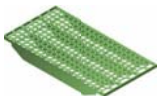













































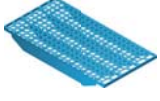

























































article	height mm
67301.98	horizontal
67302.98	vertical

METALSISTEM's plastic shelf panels are made from high quality polypropylene according to the RoHS directive and compatible for use within the food sector. The perforation is >50% of the shelf surface area. FROST shelf panels are available for use in cooling rooms. FROST shelf panels are made from specific materials and additives to achieve a higher grade of suppleness. Their use is restricted to environments below 0° C. Load bearing capacities are indicated below and refer to uniformly distributed loads, differentiated according to the degree of deflection. See also page 15, Ref. 60. Additionally to the plastic shelf panels in 300 mm width, compensation panels in 150 mm and 200 mm width are also available to suit bay lengths of 1050/1350/1650 mm.

The load bearing capacities of these compensation panels are indicated below and refer to uniformly distributed loads, differentiated according to the degree of deflection.







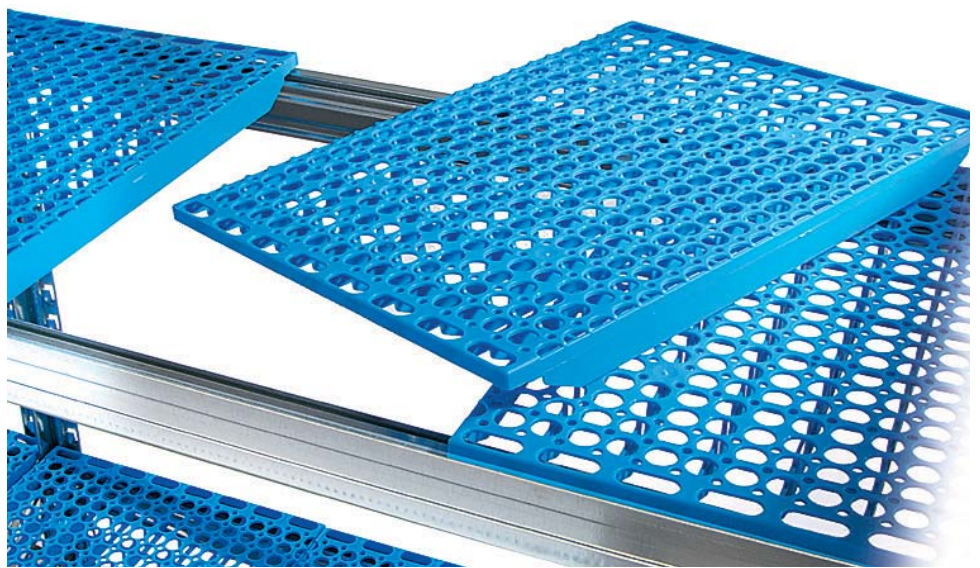







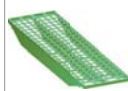

























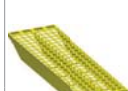





















































Notes: High temperature increase the shelves' suppleness while low temperatures make them brittle. The material used for the manufacture of standard plastic shelves is optimised to offer best performance at room temperature. Frost shelf panels contain an additive allowing the shelves to be applied in cooling rooms, at low temperatures. The use of our shelf panels in environments other than those indicated could compromise performance.



Article Code	 Low deflection  High deflection		Type of Shelf	Colour	Nominal depth (mm)	Impact resistance	Field of application (°C)		
	Load bearing capacity (daN) - u.d.l.						-30°- 0°	0°- +7°	+7°- +30°
	L=300 mm	L=300 mm							
PL30X32D1.98	40	-	FROST	Frost Green 	320		 GOOD	 NOT SO GOOD	 NOT GOOD
PL30X40D1.98	40	-			400		 GOOD	 NOT SO GOOD	 NOT GOOD
PL30X50D1.98	40	-			500		 GOOD	 NOT SO GOOD	 NOT GOOD
PL30X32C1.98	35	45	STANDARD	White 	320		 NOT GOOD	 NOT SO GOOD	 GOOD
PL30X40C1.98	35	45			400		 NOT GOOD	 NOT SO GOOD	 GOOD
PL30X50C1.98	25	45			500		 NOT GOOD	 NOT SO GOOD	 GOOD
PL30X60C1.98	25	45			600		 NOT GOOD	 NOT GOOD	 GOOD
PL30X32A1.98	35	45		Yellow 	320		 NOT GOOD	 NOT SO GOOD	 GOOD
PL30X40A1.98	35	45			400		 NOT GOOD	 NOT SO GOOD	 GOOD
PL30X50A1.98	25	45			500		 NOT GOOD	 NOT SO GOOD	 GOOD
PL30X60A1.98	25	45			600		 NOT GOOD	 NOT GOOD	 GOOD
PL30X32B1.98	35	45		Light Blue 	320		 NOT GOOD	 NOT SO GOOD	 GOOD
PL30X40B1.98	35	45			400		 NOT GOOD	 NOT SO GOOD	 GOOD
PL30X50B1.98	25	45			500		 NOT GOOD	 NOT SO GOOD	 GOOD
PL30X60B1.98	25	45			600		 NOT GOOD	 NOT GOOD	 GOOD
PL30X32B2.98	35	45	Blue 	320		 NOT GOOD	 NOT SO GOOD	 GOOD	
PL30X40B2.98	35	45		400		 NOT GOOD	 NOT SO GOOD	 GOOD	
PL30X50B2.98	25	45		500		 NOT GOOD	 NOT SO GOOD	 GOOD	
PL30X60B2.98	25	45		600		 NOT GOOD	 NOT GOOD	 GOOD	
PL30X32V1.98	35	45	Dark Green 	320		 NOT GOOD	 NOT SO GOOD	 GOOD	
PL30X40V1.98	35	45		400		 NOT GOOD	 NOT SO GOOD	 GOOD	
PL30X50V1.98	25	45		500		 NOT GOOD	 NOT SO GOOD	 GOOD	
PL30X60V1.98	25	45		600		 NOT GOOD	 NOT GOOD	 GOOD	
PL30X32N1.98	35	45	Black 	320		 NOT GOOD	 NOT SO GOOD	 GOOD	
PL30X40N1.98	35	45		400		 NOT GOOD	 NOT SO GOOD	 GOOD	
PL30X50N1.98	25	45		500		 NOT GOOD	 NOT SO GOOD	 GOOD	
PL30X60N1.98	25	45		600		 NOT GOOD	 NOT GOOD	 GOOD	



Additionally to the plastic shelf panels in 300 mm width, compensation panels in 150 mm and 200 mm width are also available to suit bay lengths of 1050/1350/1650 mm. The load bearing capacities of these compensation panels are indicated below and refer to uniformly distributed loads, differentiated according to the degree of deflection.

Article Code	 Low deflection  High deflection		Type of Shelf	Colour	Nominal depth (mm)	Impact resistance	Field of application (°C)			Article Code	 Low deflection  High deflection	
	Panel width	Load bearing capacity (daN) - u.d.l.					-30°-- 0°	0°-- +7°	+7°-- +30°		Panel width	Load bearing capacity (daN) - u.d.l.
L=200 mm	L=200 mm	L=200 mm								L=150 mm	L=150 mm	L=150 mm
PL20X32D1.98	27	-	FROST	Frost Green 	320		 GOOD	 NOT SO GOOD	 NOT GOOD	PL15X32D1.98	20	-
PL20X40D1.98	27	-			400		 GOOD	 NOT SO GOOD	 NOT GOOD	PL15X40D1.98	20	-
PL20X50D1.98	27	-			500		 GOOD	 NOT SO GOOD	 NOT GOOD	PL15X50D1.98	20	-
PL20X32C1.98	23	30	STANDARD	White 	320		 NOT GOOD	 NOT SO GOOD	 GOOD	PL15X32C1.98	18	23
PL20X40C1.98	23	30			400		 NOT GOOD	 NOT SO GOOD	 GOOD	PL15X40C1.98	18	23
PL20X50C1.98	17	30			500		 NOT GOOD	 NOT SO GOOD	 GOOD	PL15X50C1.98	13	23
PL20X32A1.98	23	30		Yellow 	320		 NOT GOOD	 NOT SO GOOD	 GOOD	PL15X32A1.98	18	23
PL20X40A1.98	23	30			400		 NOT GOOD	 NOT SO GOOD	 GOOD	PL15X40A1.98	18	23
PL20X50A1.98	17	30			500		 NOT GOOD	 NOT SO GOOD	 GOOD	PL15X50A1.98	13	23
PL20X32B1.98	23	30		Light Blue 	320		 NOT GOOD	 NOT SO GOOD	 GOOD	PL15X32B1.98	18	23
PL20X40B1.98	23	30			400		 NOT GOOD	 NOT SO GOOD	 GOOD	PL15X40B1.98	18	23
PL20X50B1.98	17	30			500		 NOT GOOD	 NOT SO GOOD	 GOOD	PL15X50B1.98	13	23
PL20X32B2.98	23	30		Blue 	320		 NOT GOOD	 NOT SO GOOD	 GOOD	PL15X32B2.98	18	23
PL20X40B2.98	23	30			400		 NOT GOOD	 NOT SO GOOD	 GOOD	PL15X40B2.98	18	23
PL20X50B2.98	17	30			500		 NOT GOOD	 NOT SO GOOD	 GOOD	PL15X50B2.98	13	23
PL20X32V1.98	23	30		Dark Green 	320		 NOT GOOD	 NOT SO GOOD	 GOOD	PL15X32V1.98	18	23
PL20X40V1.98	23	30			400		 NOT GOOD	 NOT SO GOOD	 GOOD	PL15X40V1.98	18	23
PL20X50V1.98	17	30			500		 NOT GOOD	 NOT SO GOOD	 GOOD	PL15X50V1.98	13	23
PL20X32N1.98	23	30	Black 	320		 NOT GOOD	 NOT SO GOOD	 GOOD	PL15X32N1.98	18	23	
PL20X40N1.98	23	30		400		 NOT GOOD	 NOT SO GOOD	 GOOD	PL15X40N1.98	18	23	
PL20X50N1.98	17	30		500		 NOT GOOD	 NOT SO GOOD	 GOOD	PL15X50N1.98	13	23	

METAL BASE PLATE
Ref. 4



article
SLACC001.95

HEAVY DUTY BASE PLATE
Ref. 4a



article	gauge
66999.95	1 mm
67000.95	2 mm

BEAM LOCKING PIN
Ref. 30



article
SLACC000.95

HORIZONTAL BRACE
Ref. 1a, 2a



article	depth mm
SLTRA030.95	320
SLTRA040.95	400
SLTRA050.95	500
SLTRA060.95	600
SLTRA070.95	700
SLTRA080.95	800

SHIMS FOR UNIRACK UPRIGHTS



article
SLACC079.95

SHIMS FOR STEEL BASE PLATES
Ref. 1



RAIL CURVE
Ref. 56 page 39



article
00008890.85

PLASTIC TOP CAP AND CLAMPING FOR DOUBLE UPRIGHT



article
SLACC064.98

PLASTIC TOP CAP FOR SINGLE UPRIGHT
Ref. 28



article
SLACC063.98

RAIL FASTENING SET
Ref. 56 page 39



article
00008889.98

SHORT DIAGONAL BRACE
Ref. 1a, 2a



article	depth
SLDIC030.95	320
SLDIC040.95	400
SLDIC050.95	500
SLDIC060.95	600
SLDIC070.95	700
SLDIC080.95	800

MOBILE LADDER
Ref. 56 page 39



article	nominal height mm	steps
00008879.98	2000	5
00008880.98	2500	7
00008881.98	3000	9

MOBILE LADDER GUIDE RAIL
Ref. 56 page 39



article	length mm	article	length mm
00008894.85	900	00008898.85	1500
00008895.85	1050	00008899.85	1650
00008896.85	1200	00008900.85	1800
00008897.85	1350		

DIAGONAL BRACE
Ref. 1a, 2a



article	depth
SLDIA040.95	400
SLDIA050.95	500
SLDIA060.95	600
SLDIA070.95	700
SLDIA080.95	800

CORNER BRACKETS
Ref. 67 – page 14

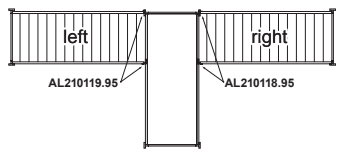
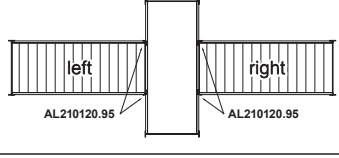

macrocode	description	application
AL 210118.95	Kit of Corner Brackets - Right made from: AL 210110.95 Corner Bracket Upright - Right AL 210114.95 Corner Bracket Beam - Right	
AL 210119.95	Kit of Corner Brackets - Left made from: AL 210111.95 Corner Bracket Upright - Left AL 210115.95 Corner Bracket Beam - Left	

REINFORCEMENT BAR
Ref. 65 page 38



article	length mm
AL210101.95	900
AL210102.95	1050
AL210103.95	1200
AL210104.95	1350
AL210105.95	1500
AL210106.95	1650
AL210107.95	1800

Reinforcement bars may be ordered in either of the following modalities:
 - Preassembled items for standard nominal bay dimensions from 900 to 1800 mm in length; see above code numbers;
 - loose items that can be assembled on site following the assembly instructions "ISTM-298".
 Please also refer to METALSISTEM Informa n 706.

Technical Specifications regarding calculation, layout, maximum load bearing capacity

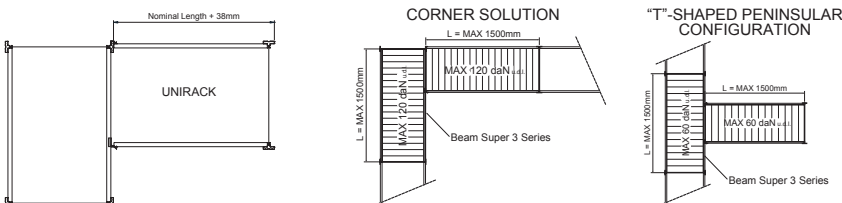

When creating corner solutions of "T"-shaped configurations, please pay attention to the following specifications:

- The corner configuration offers a maximum load bearing capacity of 120daN for both corner and receiving shelves;
- "T" shaped configurations are limited to 60daN per shelf (see sketch above);
- Only Super 3 beams can be used as receiving beams;
- The receiving and corner beam may not be longer than 1500mm;
- No more than two brackets can be placed on a receiving beam ("T" configuration);
- The peninsula of the "T" configuration may be no longer than one sole bay.
- The use of safety clips is mandatory, these are not included in the macrocodes above.

For a correct assembly of corner brackets and use of safety clips, please refer to the assembly instruction <Doc. ID ISTM-299> as well as to the indications of METALSISTEM Informa n° 708.

article	description	q.ty
AL210100.95	Connection Bracket	2
VI000175.20	Screw Peg M8x30 mm	2
36002.95	Oval Tubular Profile, zinc coated	1

Notes:
 • The oval tubular profile has been ordered in real dimensions, i.e.: real dimension = nominal dimension - 89 mm;
 • Screw pegs are supplied in standard packaging quantities.

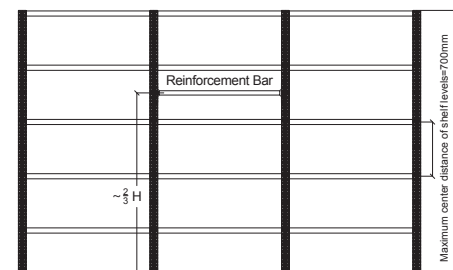

FIXED HEIGHT DIVIDERS

Ref. 23

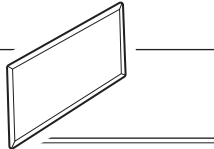

article	depth mm	height mm	article	depth mm	height mm
67720.95	320	244	67760.95	320	444
67722.95	400	244	67762.95	400	444
67724.95	500	244	67764.95	500	444
67726.95	600	244	67766.95	600	444
67728.95	700	244	67768.95	700	444
67730.95	800	244	67770.95	800	444
67740.95	320	344			
67742.95	400	344			
67744.95	500	344			
67746.95	600	344			
67748.95	700	344			
67750.95	800	344			

CLIPS FOR FIXED HEIGHT DIVIDERS

Ref. 23



article	
68110.95	double-sided
68111.95	single-sided

SIDE CLADDING

Ref. 37/39

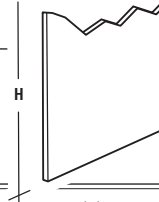

article	height x depth mm	article	height x depth mm
SLACC331.95	1368 x 320	SLACC361.95	1368 x 600
SLACC332.95	1468 x 320	SLACC362.95	1468 x 600
SLACC333.95	1868 x 320	SLACC363.95	1868 x 600
SLACC334.95	2368 x 320	SLACC364.95	2368 x 600
SLACC335.95	2468 x 320	SLACC365.95	2468 x 600
SLACC341.95	1368 x 400	SLACC371.95	1368 x 700
SLACC342.95	1468 x 400	SLACC372.95	1468 x 700
SLACC343.95	1868 x 400	SLACC373.95	1868 x 700
SLACC344.95	2368 x 400	SLACC374.95	2368 x 700
SLACC345.95	2468 x 400	SLACC375.95	2468 x 700
SLACC351.95	1368 x 500	SLACC381.95	1368 x 800
SLACC352.95	1468 x 500	SLACC382.95	1468 x 800
SLACC353.95	1868 x 500	SLACC383.95	1868 x 800
SLACC354.95	2368 x 500	SLACC384.95	2368 x 800
SLACC355.95	2468 x 500	SLACC385.95	2468 x 800

OVAL SHAPED BEAMS

Ref. 44



article	mat. gauge mm	load cap. (daN) u.d.l. per beam	length mm	article	mat. gauge mm	load cap. (daN) u.d.l. per beam
36501.95	10/10	175	900	36801.95	18/10	295
36504.95	10/10	120	1200	36804.95	18/10	200
36507.95	10/10	75	1500	36807.95	18/10	130
36510.95	10/10	52	1800	36810.95	18/10	90

Regarding design and load bearing capacity please refer to METALSISTEM Informa n° 292. In the case that the oval shaped beams are used for tyre storage, please follow the indications provided with METALSISTEM Informa n° 353.

OVAL HANDRAIL TUBE

Page 31/32



article	
SLACC118.95	for walkway end
67402.95	for inside end frame

MODULAR SLIDING GATE

Page 29 of this brochure
METALSISTEM Informa n° 547/613



article	operation with:	serviceable span mm	overall height from walkway level mm
00010780.G1	suspended guide rail	1500	1118
00010781.G1	suspended guide rail	2000	1118
00019650.G1	guide rail on ground	1500	1168
00019651.G1	guide rail on ground	2000	1168

KICK BOARD

Page 31/32

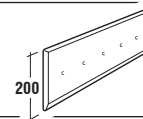

article	
SLACC119.95	for walkway end
67404.95	for inside end frame
67403.95	between bay uprights

For walkway ends, order art. n° SLACC118.95, specifying the length of the spacer bars used to build the walkway. In the case of end frames, order art. n° 67402.95, specifying the nominal frame depth. For handrails between bay uprights order the oval tubular beam in material gauge 10/10 mm, article numbers 36501-36510.95 (see above).

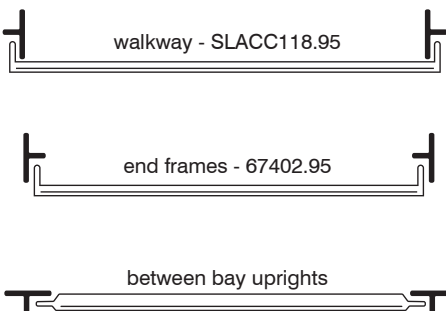

The kick boards are made from two oval tubular beams (the same used to create the handrails) fixed to the uprights and a sheet metal element fastened to the oval tubular beams with self tapping screws (art.n° 00058.20). For walkway ends, order art.n° SLACC119.95 specifying the length of the spacer bars used to build the walkway. For end frames, order art. n° 67404.95, specifying the nominal frame depth. As for longitudinal kick boards, order art.n° 67403.95, specifying the nominal bay length.

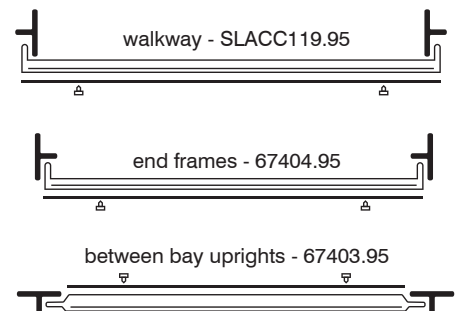

SPACER BAR FOR INSERT TUBES

Ref. 27

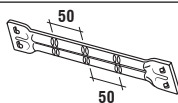

article	depth mm	Q.ty of notches to locate oval insert tubes
SLACC121.95	320	3
SLACC122.95	400	5
SLACC123.95	500	7
SLACC124.95	600	9
SLACC125.95	700	11
SLACC126.95	800	13

OVAL INSERT TUBES FOR SPACER BARS

Ref. 27

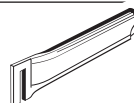

article	length mm
67421.95	900
67424.95	1200
67427.95	1500
67430.95	1800

Att.: Please, refer to Metalsistem Informa" n° 296 for design and load bearing capacity

ROW SPACER TIE BAR (clear span)

article	depth mm
SLACC117.95	clear span

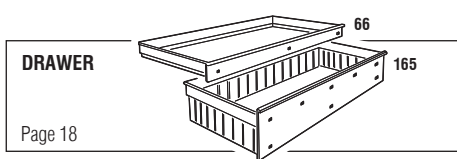

DRAWER

Page 18

article	length mm	height mm	depth mm
67830.98	900	66	400
67831.98	900	66	500
67832.98	900	66	600
67833.98	1200	66	400
67834.98	1200	66	500
67835.98	1200	66	600
67883.98	1500	66	400
67884.98	1500	66	500
67885.98	1500	66	600
67836.98	900	165	400
67837.98	900	165	500
67838.98	900	165	600
67839.98	1200	165	400
67840.98	1200	165	500
67841.98	1200	165	600
67886.98	1500	165	400
67887.98	1500	165	500
67888.98	1500	165	600

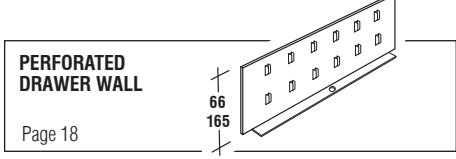

PERFORATED DRAWER WALL

Page 18

article	height mm	depth mm	for drawer height mm
67842B.95	66	400	66
67843B.95	66	500	66
67844B.95	66	600	66
67842A.95	165	400	165
67843A.95	165	500	165
67844A.95	165	600	165

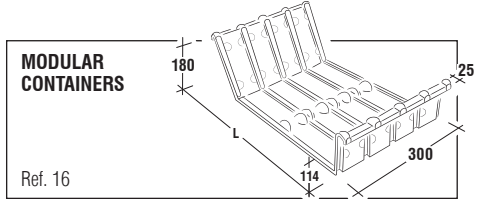

MODULAR CONTAINERS

Ref. 16

article	depth mm	load capacity daN u.d.l.
61017.95	320	90
61018.95	400	90
61019.95	500	70
61020.95	600	65
61021.95	700	60
61022.95	800	60

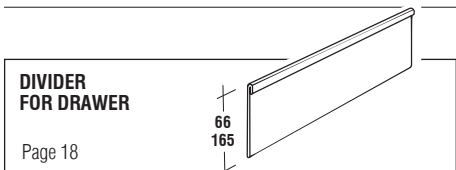

DIVIDER FOR DRAWER

Page 18

article	height mm	length mm	for drawer height mm
67845B.95	66	50	66
67846B.95	66	100	66
67847B.95	66	150	66
67848B.95	66	200	66
67849B.95	66	300	66
67850B.95	66	400	66

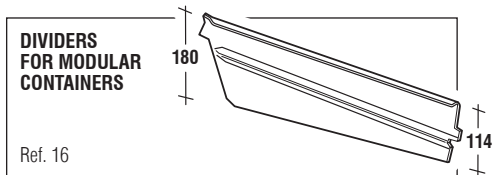

DIVIDERS FOR MODULAR CONTAINERS

Ref. 16

article	depth mm
61517.95	320
61518.95	400
61519.95	500
61520.95	600
61521.95	700
61522.95	800

KEY LOCK FOR DRAWER
Each cylinder lock is provided with two keys of the respective coding scheme.

See METALSISTEM Informa n° 679

Page 18

article	Key Coding Scheme	article	Key Coding Scheme
AL210099.801.21	801	AL210099.806.21	806
AL210099.802.21	802	AL210099.807.21	807
AL210099.803.21	803	AL210099.808.21	808
AL210099.804.21	804	AL210099.809.21	809
AL210099.805.21	805	AL210099.810.21	810

article	height mm	length mm	for drawer height mm
67845A.95	165	50	165
67846A.95	165	100	165
67847A.95	165	150	165
67848A.95	165	200	165
67849A.95	165	300	165
67850A.95	165	400	165

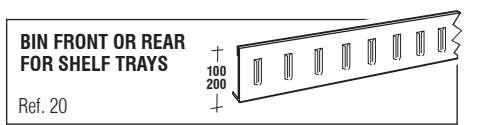

BIN FRONT OR REAR FOR SHELF TRAYS

Ref. 20

article	height x length mm
64101.95	100 x 900
64104.95	100 x 1000
64107.95	100 x 1200
64110.95	100 x 1500
64113.95	200 x 900
64116.95	200 x 1000
64119.95	200 x 1200
64122.95	200 x 1500

FASTENING CLIP FOR MODULAR CONTAINERS

Ref. 66

article

AL210005.95

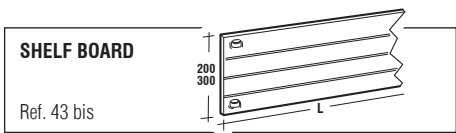

SHELF BOARD

Ref. 43 bis

article	height x length mm
64016.95	200 x 900
64019.95	200 x 1200
64022.95	200 x 1500
64025.95	200 x 1800
64031.95	300 x 900
64034.95	300 x 1200
64037.95	300 x 1500
64040.95	300 x 1800

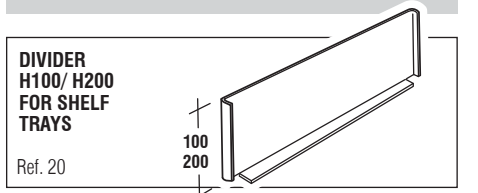

DIVIDER H100/ H200 FOR SHELF TRAYS

Ref. 20

article	depth mm	height mm	article	depth mm	height mm
67151.95	320	100	67152.95	320	200
67154.95	400	100	67153.95	400	200
67157.95	500	100	67155.95	500	200
67160.95	600	100	67156.95	600	200
67162.95	700	100	67158.95	700	200
67164.95	800	100	67159.95	800	200

TRAPEZ. SLIDING DIVIDER

Ref. 17

Ref. 17

article	depth mm
67170.95	320
67172.95	400
67174.95	500
67176.95	600
67178.95	700
67180.95	800

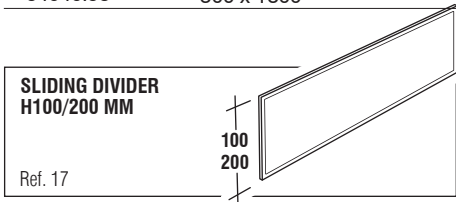

SLIDING DIVIDER H100/200 MM

Ref. 17

article	depth mm	height mm
67200.95	320	100
67204.95	400	100
67206.95	500	100
67208.95	600	100
67210.95	700	100
67212.95	800	100
67220.95	320	200
67222.95	400	200
67224.95	500	200
67226.95	600	200
67228.95	700	200
67230.95	800	200

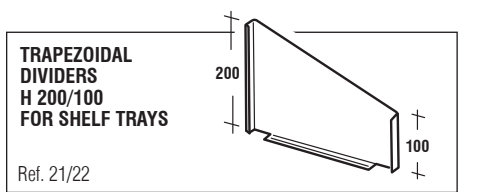

TRAPEZOIDAL DIVIDERS H 200/100 FOR SHELF TRAYS

Ref. 21/22

article	depth mm	article	depth mm
67181.95	320	67190.95	600
67184.95	400	67192.95	700
67187.95	500	67194.95	800

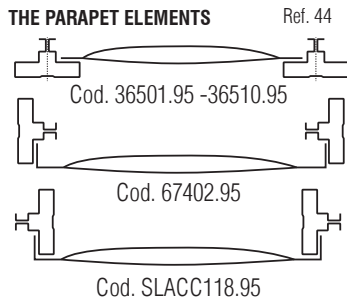

THE PARAPET ELEMENTS Ref. 44

The Unirack corridor end handrails are made up of the following components:
 -No. 1 handrail height oval beam
 -No. 1 knee height oval beam
 -No. kick board: made up of 2 oval beams and kick plate screwed against the oval beams.
 The corridor end handrail oval beams (SLACC118.95 code) used to form the handrail are ordered in their nominal dimension (real width of the corridor - 10mm) while hand rails placed within the frame use the inside frame oval beam (code 67402.95), using the nominal frame dimension and the bays facing handrails use the standard bay oval beams (code 36501.95, 36504.95, 36507.95 or 36510.95)



PLASTIC LABEL HOLDER
 Ref. 31

article

67008.98

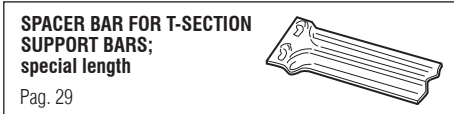

SPACER BAR FOR T-SECTION SUPPORT BARS; special length
 Pag. 29

article

99044.95



HANDRAIL FASTENING KIT FOR STAIRCASES
 Ref. 45

Art. 65001.95 composed of: q.ty

00007406.98	PLASTIC WHEEL	2
00007414.98	SQUARE INSERT WITH HOLE ø 8mm	1
00013513.20	M8X80 CSSH BOLT UNI5933 ZB	1
00014509.20	M6X20 CHS BOLT 8,8 DIN912 ZP	2
00020.20	M6 NUT 8 DIN934 ZP	2
00021.20	M8 NUT 8 DIN934 ZP	1
65005/A.95	RIGHT CONNec. HANDRAIL S123/US	1
65005/B.95	LEFT CONNec. HANDRAIL S123/US	1
SI03A018.85	CLIP WITHOUT THR. + LUGS THR.SID	1
SLACC089.95	UNIRACK BRACING BRACKET	1



HANDRAIL TUBE Ø 32x32mm
 Ref. 45

article	description	length mm
SI01C500.85	INOX 32/22 BEAM PROFILE	5000
ZN04C600.95	GALVAN. BEAM PROFILE 32/4	6000



NYLON PLUG FOR HANDRAIL
 Ref. 45

article

SI01A003.98



T-SECTION SUPPORT BAR BRACKET UNIRACK
 Ref. 42

article

SLACC130.95



T-SECTION SUPPORT BAR - H58 FOR "INNER FRAMES"
 Pages 28 - 29 - 38

article	length mm	security pin
SLACC222.95	900	SLACC003.95
SLACC224.95	1200	
SLACC226.95	1500	



WALKWAY SUPPORT T-SECTION H58 FOR WALKWAYS LENGTH = 6200 MM
 Ref. 41

article

67015.95

SLACC003.95

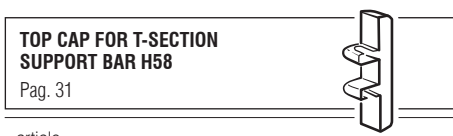

TOP CAP FOR T-SECTION SUPPORT BAR H58
 Pag. 31

article

67026.98

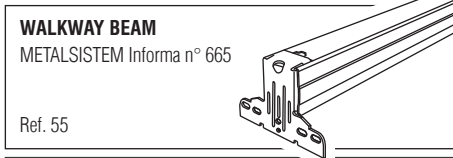

WALKWAY BEAM
 METALSISTEM Informa n° 665
 Ref. 55

article	description	q.ty
AI210013.95	PROFILE 70X70/6 PALLET SUPPORT BAR	1
AI210082.95	WALKWAY BEAM BRACKET	2
69864.98	STEEL PLANK FIX. BRACKET	1
00058.20	5,5X19 HEXSDAP SCREW	2

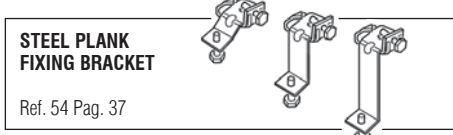

STEEL PLANK FIXING BRACKET
 Ref. 54 Pag. 37

article

STEEL PLANK CLAMP
 M8X16 BOLT

69829.95
00056.20

BRACKET UP TO 20 MM + 10X20 BOLT	69861.98
BRACKET UP TO 40 MM + 10X20 BOLT	69862.98
BRACKET UP TO 60 MM + 10X20 BOLT	69863.98



FLOOR FIXING DOWEL

article

00040.20

length mm: 8 x 50



PLASTIC STRIP LENGTH = 3000 MM
 Ref. 29

article

67020.98

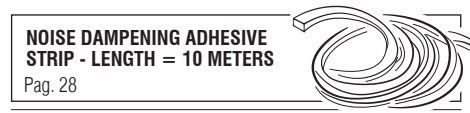

NOISE DAMPENING ADHESIVE STRIP - LENGTH = 10 METERS
 Pag. 28

article

67021.98



CHIPBOARD CLIP
 Ref. 15

article

67025.95



WALL BRACKET UNIRACK
 Ref. 33

article

SLACC131.95



FRAME BACK TO BACK CLAMPS WITH BOLTS
 Ref. 32

article

SLACC010.95



NUT AND BOLT
 Ref. 55

dimension mm	bolt code n°	nut code n°
6x10	00001.20	00020.20
6x20	00005.20	00020.20
6x30	00003.20	00020.20
6x35	00006.20	00020.20

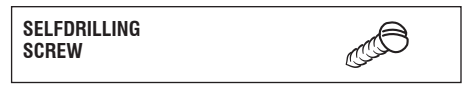

SELFDRILLING SCREW

article

length mm

00016.20	6x18
00017.20	3,5x13

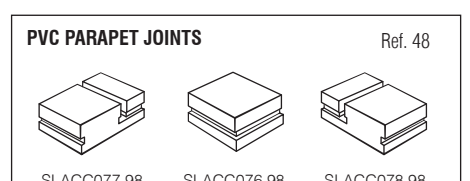

PVC PARAPET JOINTS Ref. 48

SLACC077.98 SLACC076.98 SLACC078.98

article

description

SLACC077.98	PVC PARAPET JOINT - AT RIGHT
SLACC076.98	PVC LONGITUD.HANDRAIL JOINT
SLACC078.98	PVC PARAPET JOINT - AT LEFT

CROSS BRACING UNIRACK SHELVING

Regarding design, calculation, assembly instructions and ordering, please refer to the technical manual "ISQ03_04/C-012 - CROSS BRACINGS FOR LIGHT DUTY SHELVING".

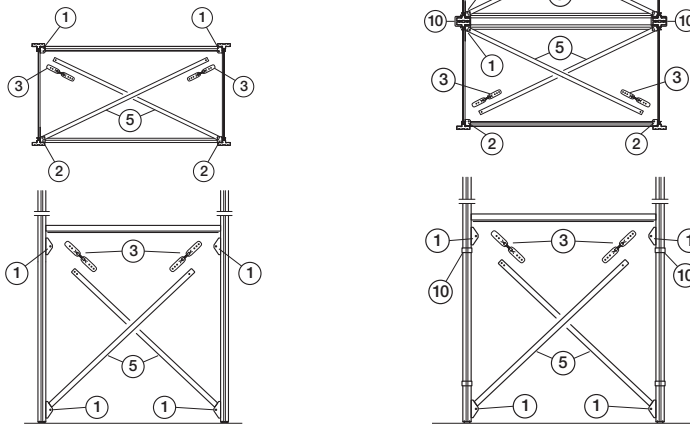

Cross bracings (horizontal and vertical ones) have to be used in Unirack shelving structures with frame heights exceeding 3000 mm. The sketches shown above explain the make up and assembly of the cross bracing concept referring to a 3000 mm high frame within a single and double sided shelving row.

MACRO-CODE SLACC012.95 for single sided shelving. The macrocode SLACC012.95 comprises all components shown in the sketch, except items 2-3.

article	Macrocode SLACC012.95 q.ty of components
SLACC089.95	4
SLACC089P.95	2
68053.95	8
00020.20	28
00027.20	12
00035.20	12
00036.20	4

MACRO-CODE SLACC013.95 for double sided shelving. The macrocode SLACC013.95 comprises all components shown in the sketch, except items 2-3.

article	Macrocode SLACC013.95 q.ty of components
SLACC089.95	6
SLACC089P.95	4
68053.95	12
00020.20	44
00027.20	20
00035.20	18
00036.20	6
SLACC010.95	2

HEAVY DUTY BRACING SYSTEM

METALSISTEM's heavy duty bracing system has been designed for its Unirack series and distinguishes itself for its high performance while allowing for a reduction of braced bays per row. The system is also easy and fast to assemble as with only one bolted connection the stirrups and brackets are tightened to the upright. See also indications of METALSISTEM Informa n° 688 and embedded assembly video.





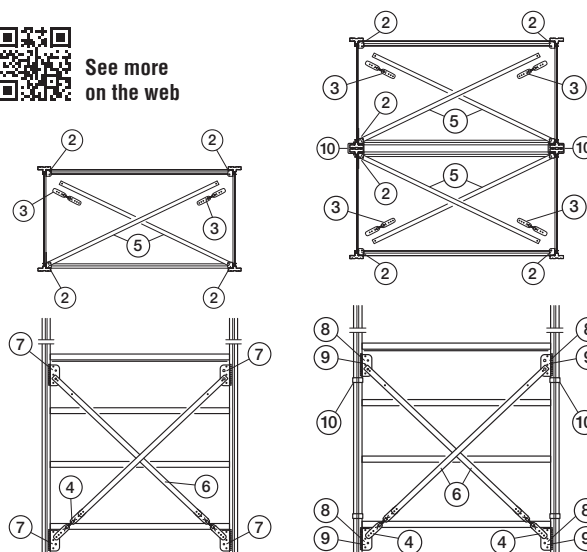







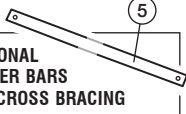

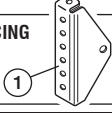
See more on the web



HEAVY DUTY BRACING COMPONENTS

article	description
SLACC116.95	Vertical Bracing Bracket – single sided rows
SLACC507.95	Vertical Bracing Bracket – double sided rows - at right
SLACC508.95	Vertical Bracing Bracket – double sided rows - at left
SLACC089P.95	Horizontal Bracing Bracket

CROSS BRACING UNIRACK SERIES

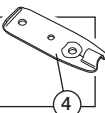
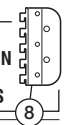
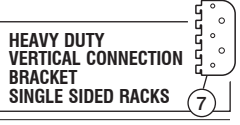
 <p>DIAGONAL SPACER BARS FOR CROSS BRACING</p> <p>article</p> <p>68049.95</p>	 <p>FRAME BACK TO BACK CLAMPS WITH BOLTS</p> <p>article</p> <p>SLACC010.95 x2</p>
 <p>CROSS BRACING FASTENING BRACKET</p> <p>article</p> <p>SLACC089.95</p>	 <p>TURNBUCKLE (1/2 component) FOR CROSS BRACING</p> <p>article</p> <p>68053.95</p>
 <p>SCREW 6x16 mm</p> <p>article</p> <p>00035.20</p>	 <p>SCREW 6x30 mm</p> <p>article</p> <p>00027.20</p>
 <p>SCREW 6x70 mm</p> <p>article</p> <p>00036.20</p>	 <p>SCREW 10x90 mm</p> <p>article</p> <p>00076.20</p>
 <p>SCREW 10x20 mm</p> <p>article</p> <p>00075.20</p>	 <p>NUT 6 mm</p> <p>article</p> <p>00020.20</p>
 <p>NUT 10 mm</p> <p>article</p> <p>00034.20</p>	 <p>DIAGONAL SPACER BARS FOR CROSS BRACING 42x2</p> <p>article</p> <p>08740.95</p>
 <p>HORIZONTAL BRACING BRACKET CORRIDOR FACING</p> <p>article</p> <p>SLACC089P.95</p>	 <p>1/2 TURNBUCKLE HOLE DIAM.10</p> <p>article</p> <p>08886.95</p>
 <p>HEAVY DUTY VERTICAL CONNECTION BRACKET DOUBLE SIDED RACKS</p> <p>macrocode</p> <p>SLACC509.95</p> <p>made of q.ty</p> <p>SLACC507.95 2</p> <p>SLACC508.95 2</p>	 <p>HEAVY DUTY VERTICAL CONNECTION BRACKET SINGLE SIDED RACKS</p> <p>macrocode</p> <p>SLACC506.95</p> <p>made of q.ty</p> <p>SLACC116.95 2</p>

Regarding ordering dimensions of the bracing stirrups please refer to METALSISTEM Informa n° 688.

FLOW TRACK PROFILES

see page 40

article code N°	roller pitch mm
00004816.95	33
00004817.95	49,5
00004818.95	66
00004819.95	82,5
00004820.95	99

C-SECTION PROFILE H29 FOR FLOW TRACKS

see page 40

article code N°	bay length mm
00019796.95	900
00019797.95	1200
00019798.95	1500

Article Code N°

00004816
33 mm

00004817
49,5 mm

00004818
66 mm

00004819
82,5 mm

00004820
99 mm

REMOVABLE ROLLER BED DIVIDER

Page 40

article	description
ZN04M000.95	GALVANISED PROFILE 32/4 SPEC.
MH210001.98	ROLLER BED SEPARATOR JOINTS

RUNWAY DIVIDER FOR ROLLER SHELVES

Page 40

article code N°	runway depth mm
00007963.95	624
00006421.95	1285

00004357.95 FLOW TRACK WITHOUT ROLLERS

LOAD BEARING CAPACITY <daN> OF SINGLE FLOW TRACK PROFILES

distance between supports - mm	00004816 33 mm	00004817 49,5 mm	00004818 66 mm	00004819 82,5 mm	00004820 99 mm
200	18	12	9	7	6
300	27	18	14	11	9
400	36	24	18	15	12
500	36	30	23	18	15
600	31	31	27	22	18
700	27	27	27	25	21
800	20	20	20	20	20
900	16	16	16	16	16
1000	13	13	13	13	13
1100	11	11	11	11	11
1200	9	9	9	9	9
1300	8	8	8	8	8
1400	7	7	7	7	7
1500	6	6	6	6	6
1600	5	5	5	5	5
1700	5	5	5	5	5
1800	4	4	4	4	4
1900	4	4	4	4	4
2000	3	3	3	3	3

FLOW TRACK CUT PITCHES mm

359	821	1283	1745	2207	2669	3131	3593
392	854	1316	1778	2240	2702	3164	3626
425	887	1349	1811	2273	2735	3197	3659
458	920	1382	1844	2306	2768	3230	3692
491	953	1415	1877	2339	2801	3263	3725
524	986	1448	1910	2372	2834	3296	3758
557	1019	1481	1943	2405	2867	3329	3791
590	1052	1514	1976	2438	2900	3362	3824
623	1085	1547	2009	2471	2933	3395	3857
656	1118	1580	2042	2504	2966	3428	3890
689	1151	1613	2075	2537	2999	3461	3923
722	1184	1646	2108	2570	3032	3494	3956
755	1217	1679	2141	2603	3065	3527	3989
788	1250	1712	2174	2636	3098	3560	4022

Notes: the flow track profiles are made from galvanized, structural steel. The yellow polypropylene plastic rollers are inserted into the tracks at varying pitches of either 33, 49.5, 66, 82.5 or 99 mm. The load bearing capacity of the flow track profile has been calculated on the basis of the application of a uniformly distributed load with a deflection of L/500. ("L" is the distance between supports, ranging from 200 to 2000 mm). The maximum load bearing capacity of a single roller is 3 daN.

PLASTIC LINE (Page 19)

See more on the web



Open fronted bins with very strong structure. Easily to be placed one upon another. Large front label holder. Made from high density polyethylene, for use in environments ranging from -40°C up to +80°C. Fracture and breakage proof. Resistant to acids, oils, solvents and detergents. Ergonomic line with comfortable handles for lifting. Base completely flat and anti-skid. Full length return to clip to louvred panels. Brilliant colours and pleasant design.

BULL 1 / K1

L. 105 x D. 88/70 x H. 54 mm

BULL 2 / K2

L. 105 x D. 167/140 x H. 82 mm

BULL 3 / K3

L. 144 x D. 237/190 x H. 123 mm

BULL 4 / K4

L. 205 x D. 345/270 x H. 164 mm

BULL 5 / K5

L. 298 x D. 485/400 x H. 189 mm

BULL 6/D BULL 6
K6/D K6

● = available without fixed divider

L. 372 x P. 600/460 x H. 250 mm

BULL 7 BULL 7/D

◆ = available with fixed divider

L. 442 x D. 700/540 x H. 300 mm

BULL 4/D K4/D

Can be equipped with 1, 2, or 3 mobile dividers

L. 406 x D. 345/270 x H. 164 mm

METALSISTEM



Our dedication to making a difference: creating **MORE VALUE** with **LESS IMPACT!**
 METALSISTEM is proud to adopt **ECO-EFFICIENCY** concepts in its business model.
 ZERO emission and ZERO ecological impact thanks to a **UNIQUE MANUFACTURING PROCESS!**
 METALSISTEM has achieved energy self-sufficiency through the use of renewable resources.



See more on the web

UNIRACK

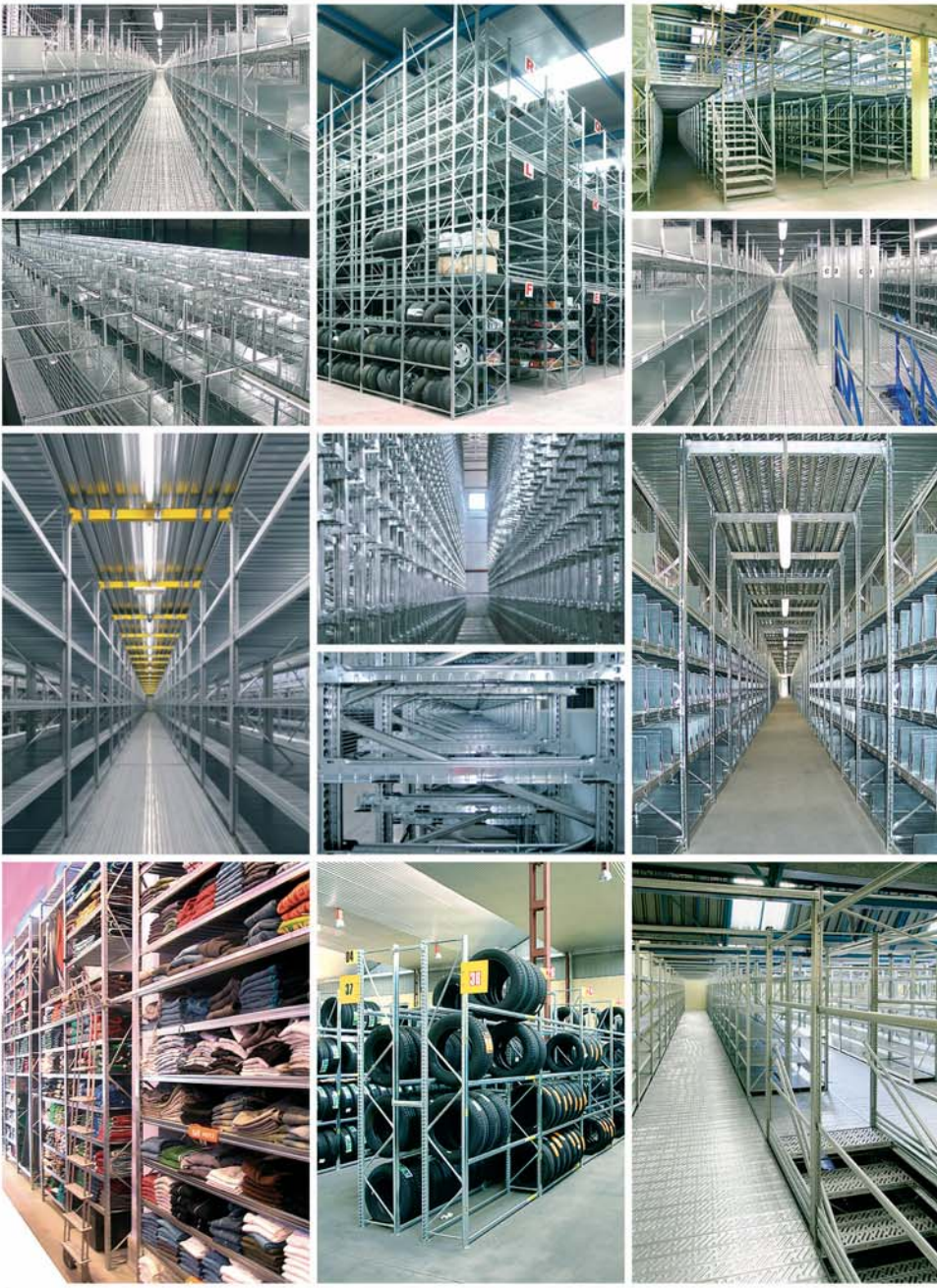

MODULAR STEEL STORAGE SYSTEMS